















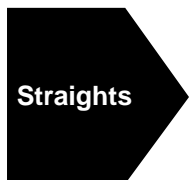
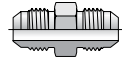
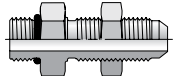

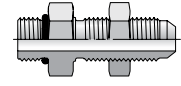
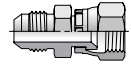
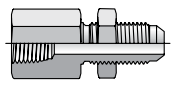
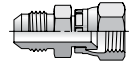
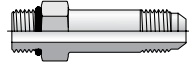

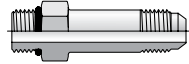
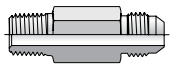
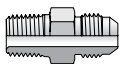
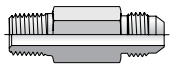





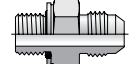
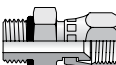

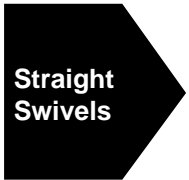
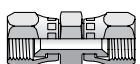

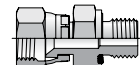
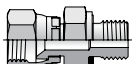

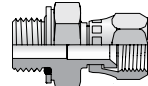
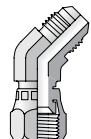
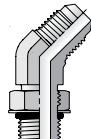
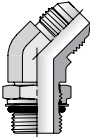
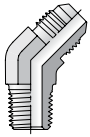
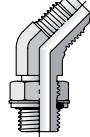
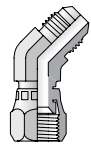
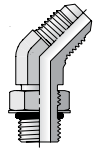
Triple-Lok™ & Triple-Lok™ 2 37° Flare Tube Fittings

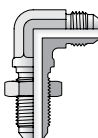
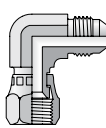
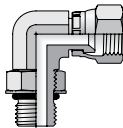
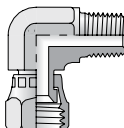
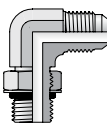
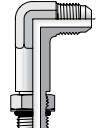
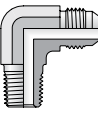
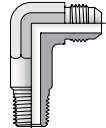
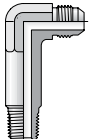
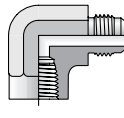
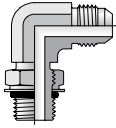
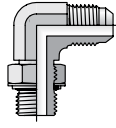
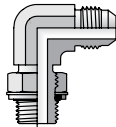
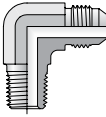
B

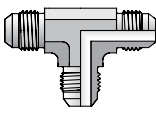
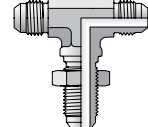
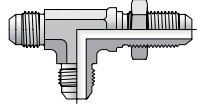
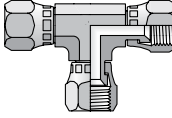
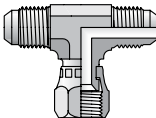
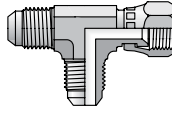
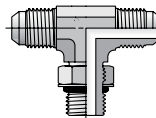
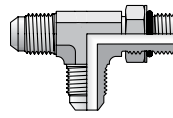
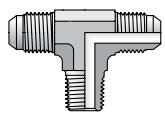
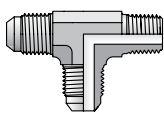
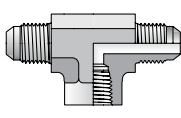
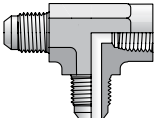
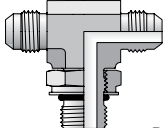
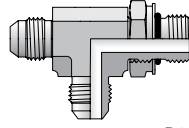
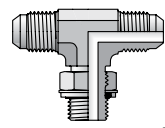
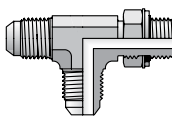
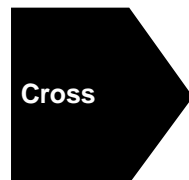

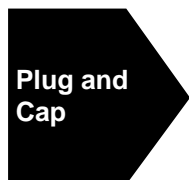

ENGINEERING YOUR SUCCESS.

<p>Nuts, Sleeves, Locknuts</p>	<p>BTX Nut</p>  <p>B9</p>	<p>TX and TX Metric Sleeve</p>  <p>B9</p>	<p>WLN Bulkhead Locknut</p>  <p>B10</p>	<p>SBR Braze Ring</p>  <p>B10</p>		
<p>Straights</p>	<p>HTX Union</p>  <p>B10</p>	<p>LHTX Large Hex Union</p>  <p>B10</p>	<p>WTX Bulkhead Union</p>  <p>B11</p>	<p>WF50X SAE-ORB / 37° Bulkhead</p>  <p>B11</p>	<p>WFTX NPTF / 37° Bulkhead</p>  <p>B11</p>	
<p>WGTX NPTF / 37° Bulkhead</p>  <p>B12</p>	<p>HXH6 Extender and Expander</p>  <p>B12</p>	<p>TRTX / TRTXN Reducer</p>  <p>B13</p>	<p>F50X SAE-ORB / 37° Flare</p>  <p>B14</p>	<p>FF50X SAE-ORB / 37° – Long</p>  <p>B14</p>	<p>XHB3 Braze Socket / 37° Flare</p>  <p>B14</p>	
<p>FTX NPTF / 37° Flare</p>  <p>B15</p>	<p>FFTX NPTF / 37° Flare – Long</p>  <p>B15</p>	<p>GTX NPTF / 37° Flare</p>  <p>B15</p>	<p>F870MX ISO 6149 / 37° Flare</p>  <p>B16</p>	<p>F82EDMX Metric-ED / 37° Flare</p>  <p>B16</p>	<p>F80MX Metric-ORR / 37° Flare</p>  <p>B16</p>	
<p>F42EDMX BSPP-ED / 37° Flare</p>  <p>B16</p>	<p>F40MX BSPP-ORR / 37° Flare</p>  <p>B17</p>	<p>G4MX BSPP / 37° Flare</p>  <p>B17</p>	<p>F3MX BSPT / 37° Flare</p>  <p>B17</p>	<p>Straight Swivels</p>		
<p>F650X SAE-ORB / 37° Swivel</p>  <p>B18</p>	<p>F6X NPTF / 37° Swivel</p>  <p>B18</p>	<p>G6X NPTF / 37° Swivel</p>  <p>B18</p>	<p>F6870MX ISO-6149 / 37° Swivel</p>  <p>B18</p>	<p>F680MX Metric-ORR / 37° Swivel</p>  <p>B19</p>	<p>F682EDMX Metric-ED / 37° Swivel</p>  <p>B19</p>	
<p>F642EDMX BSPP-ED / 37° Swivel</p>  <p>B19</p>	<p>F63MX BSPT / 37° Swivel</p>  <p>B19</p>	<p>45° Elbows</p>		<p>WNTX Bulkhead Union</p>  <p>B20</p>	<p>V6X 37° Swivel Elbow</p>  <p>B20</p>	<p>V50X SAE-ORB / 37° Flare</p>  <p>B20</p>
<p>V870MX ISO-6149 / 37° Flare</p>  <p>B20</p>	<p>VTX NPTF / 37° Flare</p>  <p>B21</p>	<p>V40MX BSPP-ORR / 37° Flare</p>  <p>B21</p>	<p>V3MX BSPT / 37° Flare</p>  <p>B21</p>	<p>90° Elbows</p>		<p>ETX Union Elbow</p>  <p>B21</p>

<p>WETX Bulkhead Union</p>  <p>B22</p>	<p>C6X 37° Swivel Elbow</p>  <p>B22</p>	<p>AOEX6 SAE-ORB / 37° Swivel</p>  <p>B22</p>	<p>X6EF NPTF / 37° Swivel</p>  <p>B23</p>	<p>C50X SAE-ORB / 37° Flare</p>  <p>B23</p>	<p>CC50X SAE-ORB / 37° – Long</p>  <p>B23</p>
<p>CTX NPTF / 37° Flare</p>  <p>B24</p>	<p>CCTX NPTF / 37° Flare – Long</p>  <p>B24</p>	<p>CCCTX NPTF / 37° – Extra Long</p>  <p>B24</p>	<p>DTX NPTF / 37° Flare</p>  <p>B25</p>	<p>C870MX ISO-6149 / 37° Flare</p>  <p>B25</p>	<p>C80MX Metric-ORR / 37° Flare</p>  <p>B25</p>
<p>C40MX BSPP-ORR / 37° Flare</p>  <p>B26</p>	<p>C3MX BSPT / 37° Flare</p>  <p>B26</p>	<p>Tees</p> 	<p>JTX Union Tee</p>  <p>B26</p>	<p>WJTX Bulkhead Branch Tee</p>  <p>B27</p>	<p>WJJTX Bulkhead Run Tee</p>  <p>B27</p>
<p>JX6 37° Swivel Union Tee</p>  <p>B28</p>	<p>S6X 37° Swivel Branch Tee</p>  <p>B28</p>	<p>R6X 37° Swivel Run Tee</p>  <p>B28</p>	<p>S50X SAE-ORB Branch Tee</p>  <p>B29</p>	<p>R50X SAE-ORB Run Tee</p>  <p>B29</p>	<p>STX NPTF Branch Tee</p>  <p>B30</p>
<p>RTX NPTF Run Tee</p>  <p>B30</p>	<p>OTX NPTF Branch Tee</p>  <p>B30</p>	<p>MTX NPTF Run Tee</p>  <p>B30</p>	<p>S870MX ISO 6149 Branch Tee</p>  <p>B31</p>	<p>R870MX ISO 6149 Run Tee</p>  <p>B31</p>	<p>S40MX BSPP-ORR Branch Tee</p>  <p>B31</p>
<p>R40MX BSPP-ORR Run Tee</p>  <p>B31</p>	<p>Cross</p> 	<p>KTX Union Cross</p>  <p>B32</p>	<p>Plug and Cap</p> 	<p>PNTX 37° Plug</p>  <p>B32</p>	<p>FNTX 37° Cap</p>  <p>B32</p>
<p>T22X Mountie Cap</p>  <p>B32</p>					

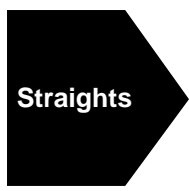
Triple-Lok® 2 Soft Seal Flare Tube Fittings

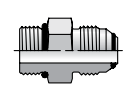
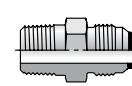
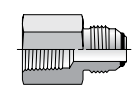
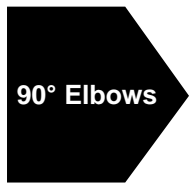
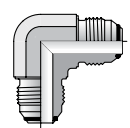
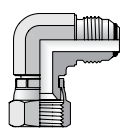
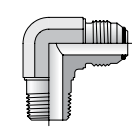
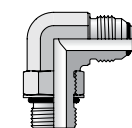
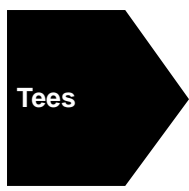
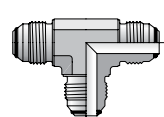
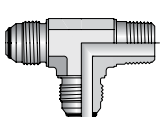
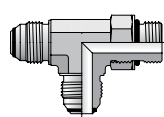
 <p>Straights</p>	<p>HTXO Union</p>  <p>B33</p>	<p>F5OXO SAE-ORB / 37° Flare</p>  <p>B33</p>	<p>FTXO NPTF / 37° Flare</p>  <p>B33</p>	<p>GTXO NPTF / 37° Flare</p>  <p>B33</p>	
	 <p>90° Elbows</p>	<p>ETXO Union Elbow</p>  <p>B34</p>	<p>C6XO 37° Swivel Elbow</p>  <p>B34</p>	<p>CTXO NPTF / 37° Flare</p>  <p>B34</p>	<p>C5OXO SAE-ORB / 37° Flare</p>  <p>B34</p>
	 <p>Tees</p>	<p>JTXO Union Tee</p>  <p>B35</p>	<p>RTXO 37° Swivel Run Tee</p>  <p>B35</p>	<p>R5OXO SAE-ORB Run Tee</p>  <p>B35</p>	

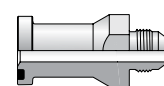
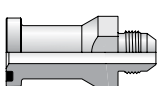
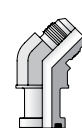
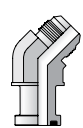
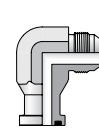
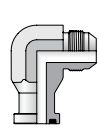

Flange Adapters (Shown in Section L)

 <p>SAE Flange Adapters</p>	<p>XHQ1 Code 61 / 37° Flare</p>  <p>L12</p>	<p>XHQ2 Code 62 / 37° Flare</p>  <p>L12</p>	<p>XVQ1 Code 61 / 37° Flare</p>  <p>L30</p>	<p>XVQ2 Code 62 / 37° Flare</p>  <p>L30</p>	<p>XEQ1 Code 61 / 37° Flare</p>  <p>L31</p>
<p>XEQ2 Code 62 / 37° Flare</p>  <p>L31</p>					

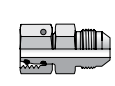
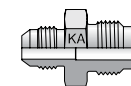
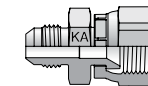
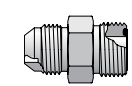
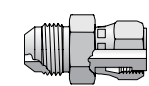
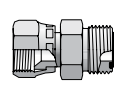
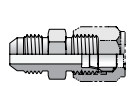
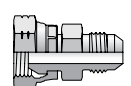
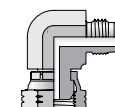
Conversion Adapters (Shown in Sections J and K)

 <p>Conversion Adapters</p>	<p>XHU86 Metric Swivel (EO) / 37°</p>  <p>K5</p>	<p>XHMKA Komatsu 30° / 37° Flare</p>  <p>J5</p>	<p>XHMKA6 Komatsu 30° Swivel / 37°</p>  <p>J5</p>	<p>XHLO 37° Flare / ORFS</p>  <p>K3</p>	<p>XHL6 37° Flare / ORFS Swivel</p>  <p>K3</p>
	<p>LOHX6 ORFS / 37° Swivel</p>  <p>K3</p>	<p>XHBU 37° Flare / Flareless</p>  <p>K4</p>	<p>XHMK46 37° Flare / BSPP Swivel</p>  <p>K5</p>	<p>XEMK46 37° Flare / BSPP Swivel</p>  <p>K5</p>	

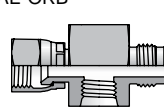
Diagnostic and Orifice Fittings (Shown in Section M)

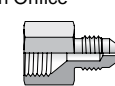
 <p>Diagnostic Tee</p>	<p>XHX6G5TP 37° Flare / 37° Swivel / SAE-ORB</p>  <p>M5</p>	 <p>Orifice Fitting</p>	<p>XHX7 37° Flare / 37° Female with Orifice</p>  <p>M9</p>
--	---	---	--



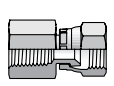
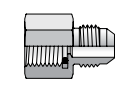



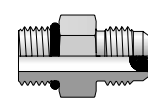

Gauge Fittings (Shown in Section M)

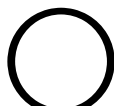
 <p>Gauge Fittings</p>	<p>G6X NPT Gauge / 37° Swivel</p>  <p>M7</p>	<p>G4MXSMO BSPP Gauge / 37° Flare</p>  <p>M6</p>
--	--	--

Screen Fittings (Shown in Section M)

 <p>Screen Fittings</p>	<p>Screen Fittings</p>  <p>M12</p>
--	---

O-Rings and Seals (Shown in Section N)

 <p>O-Rings and Seals</p>	<p>XO O-Ring</p>  <p>N4</p>	<p>SAE O-Ring</p>  <p>N4</p>	<p>ISO 6149 O-Ring</p>  <p>N5</p>	<p>Metric O-Ring</p>  <p>N5</p>	<p>Metric Retaining Ring</p>  <p>N5</p>
	<p>BSPP O-Ring</p>  <p>N6</p>	<p>BSPP Retaining Ring</p>  <p>N6</p>	<p>Eoelastic Seal Ring</p>  <p>N6</p>		

Triple-Lok

Parker Triple-Lok fittings meet the strict requirements of SAE J514 and ISO 8434-2 industry standards for 37° flare fittings. Its design is simple. It uses an easily produced flare at the tube end to seal and hold fluid under high pressure. The fitting consists of three pieces: the body, sleeve and nut. The tube is flared at a 37° angle (74° included angle) and held between the fitting nose (seat) and the sleeve (support) with the nut as shown in Fig. B1, providing a very effective seal between the fitting nose and the tube flare.

The design of Triple-Lok fittings is very efficient. The fitting incorporates the smallest seal area of all fitting types. This seal area, as seen in Fig. B1, is only slightly larger than the fluid flow area. The small seal area results in a compact design, low assembly torque, and a relatively high-pressure capability.

How Triple-Lok Fittings Work

Tightening of the nut clamps the tube flare between the body nose (seat) producing a leak tight connection. This clamping on the 37° taper provides a measure of elasticity to the joint helping it to resist loosening under vibration. The clamping force results in a small radial load that tends to deform the fitting nose radially. The resistance of the nose to elastic deformation provides a constant preload (similar to a lockwasher) keeping it tight.

The clamping force provided by the nut resists the opposing force of the fluid under pressure. The joint remains leak tight as long as the clamping force is higher than the opposing pressure load. Properly assembled Triple-Lok fittings with appropriate tube will seal consistently under pressure until tube bursts.

Sealing in Triple-Lok fittings takes place between two smooth metal surfaces, the fitting nose and inside of the tube flare. Therefore, the sealing surfaces have to be smooth, free of any nicks, scratches, spiral tool marks, splits or weld beads. Seamless or welded and drawn fully annealed tube is recommended for Triple-Lok fittings for ease in flaring and bending. Certain types of harder tubes that are not fully annealed may not be suitable for flaring due to the potential for immediate or long-term cracking of the tube flare. For specific tube type and wall thickness recommendations, please see Table U3 in the Appendix Section.

International Acceptance

The versatility of 37° flare fittings is a primary reason for its worldwide acceptance. To illustrate the versatility of Triple-Lok, refer to Fig. B2. The Triple-Lok adapter is attachable to either inch tube, metric tube, or a hose assembly. To adapt to metric tube, simply change the sleeve (using the standard inch adapter and nut). Please see Table U4 in the Appendix Section for a clear illustration of every "convertible sleeve" connection for the 37° design. For example, for a 25 mm tube assembly, a standard SAE -16 (1") flare fitting and nut would be used, however, a 25 mm metric sleeve (TXS25) would replace the inch size sleeve.

Triple-Lok fittings are available with many different port options for the various international hydraulic ports available, such as SAE straight thread, NPT/NPTF, BSPP, BSPT and Metric (including ISO 6149).

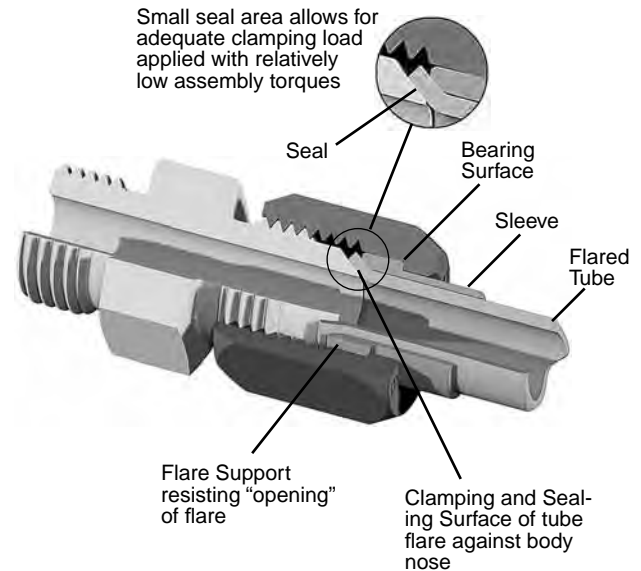

Fig. B1 – Triple-Lok Design and Features

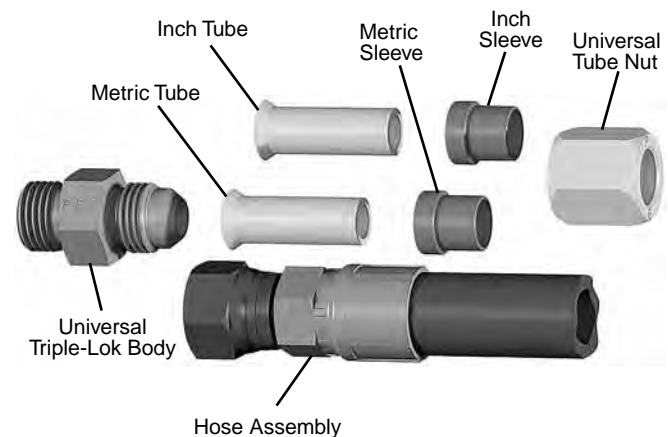

Fig. B2 – Triple-Lok's Adaptability to Inch Tube, Metric Tube, or Hose Assemblies

Triple-Lok 2

Triple-Lok 2 combines the versatility of stainless steel Triple-Lok with the added advantage of an elastomeric seal. It incorporates an O-ring that is positioned in the nose of the 37° flare so that elastomeric sealing occurs with the mating flared tube. Similar to the standard stainless steel Triple-Lok, Triple-Lok 2 consists of three pieces: the body (with O-ring), the standard Triple-Lok sleeve and standard Triple-Lok nut. The tube end is flared at a 37° angle (74° included angle) and held between the fitting nose and sleeve with the nut as shown in Fig. B3, providing a very effective elastomeric seal between the fitting nose and the tube flare.

The Parker Advantage

Robust Port Stud: The adjustable port stud is manufactured with a longer locknut designed to cover the uppermost threads completely. Since the backup washer is never exposed to the upper threads, it cannot be damaged during assembly. During assembly, exposed upper threads, as common with fittings from other fitting manufacturers, can lead to a deformed backup washer that can pinch the o-ring and create an o-ring extrusion gap that has the potential to leak. The longer locknut also provides a greater grip area for the wrench.

Superior Plating: Superior plating gives Parker steel tube fittings unmatched protection against red rust. In neutral salt spray test per ASTM B117, Parker Triple-Lok fittings substantially exceeded the SAE requirement of 96 hours to red rust.

Pre-Lubricated Stainless Steel Tube Nut: All stainless steel Triple-Lok tube nuts have a pre-applied anti-seize lubricant to prevent galling during assembly.

Triple-Lok 2: Triple-Lok 2 utilizes an elastomeric seal in the flare nose for improved seal reliability in applications where stainless steel fittings are required.

Wide Selection: Triple-Lok fittings are available as standard in steel, stainless steel, brass and aluminum materials. Coupled with its broad line of configurations and port end options, Parker is well positioned to better service the hydraulic requirements of the international markets.

Reference locations

Dynamic Pressure Ratings: Please refer to the last column of the part number tables located on the following pages of this section for the appropriate dynamic pressure ratings.

Recommended Tube Wall Thickness: Please refer to Table U3 located in the Appendix section.

Assembly and Installation: Please refer to Triple-Lok Assembly located within the Assembly/Installation section of this catalog.

Standard material specifications: Please refer to Table U1 located in the Appendix section.

Seal Material Selection: Please refer to Table T8 in the General Technical section of this catalog.

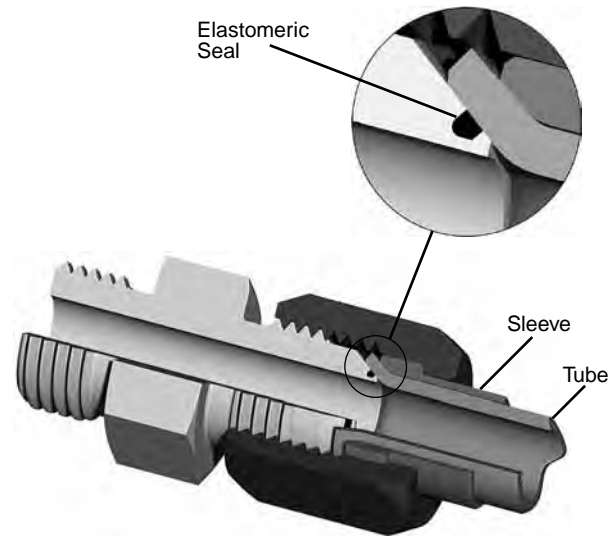
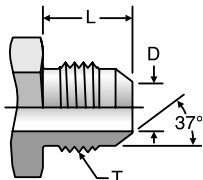

Fig. B3 – Triple-Lok 2 Design and Features

Dimensions and pressures for reference only, subject to change.

Triple-Lok 37° Flared Tube Ends



Triple-Lok Male Flare Tube End

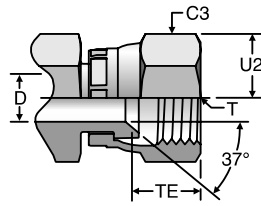

Triple-Lok Swivel

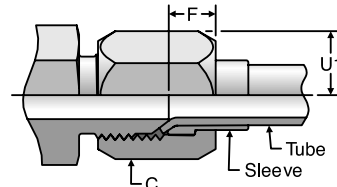

Triple-Lok Tube End Assembly

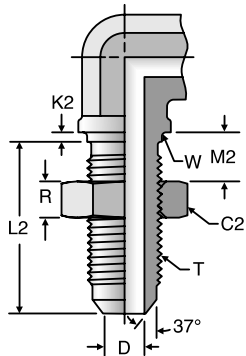

Triple-Lok Shape Bulkhead

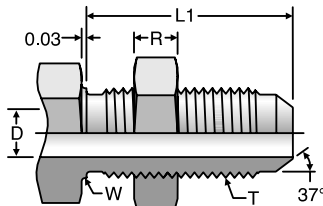

Triple-Lok Straight Bulkhead

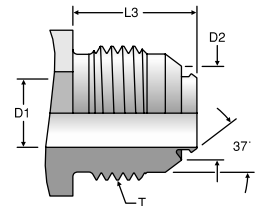

Triple-Lok 2 Male Flare Tube End

SAE Dash Size	Tube O.D.		T	C	C2	C3	D	D1	L	L3	F	TE	K2	L1	L2	R	W ¹⁾	Max Bulkhead Thickness		Min. Flare Dia.										
																		Thread	Tube Nut Hex		Bulkhead Locknut Hex	Swivel Nut Hex	Max Drill	Male Turn Back	Assembly Allowance		Bulkhead			
																									Tube Nut	Swivel Nut	Pilot Length - Shapes	Length - Straights	Length - Shapes	Locknut Thickness
2	1/8	—	5/16-24	3/8	9/16	7/16	—	0.062	—	0.45	—	0.19	0.31	0.094	1.11	0.92	0.22	0.313	0.38	0.25	—									
3	3/16	—	3/8-24	7/16	5/8	1/2	—	0.125	—	0.48	—	0.25	0.33	0.094	1.11	0.92	0.22	0.375	0.38	0.25	—									
4	1/4	6	7/16-20	9/16	11/16	9/16	14	0.172	0.156	0.55	0.56	0.19	0.34	0.094	1.20	1.02	0.28	0.438	0.38	0.25	0.254									
5	5/16	8	1/2-20	5/8	3/4	5/8	16	0.234	0.217	0.55	0.56	0.30	0.38	0.094	1.20	1.02	0.28	0.500	0.38	0.25	0.314									
6	3/8	10	9/16-18	11/16	13/16	11/16	17	0.297	0.263	0.56	0.57	0.28	0.38	0.094	1.28	1.09	0.27	0.563	0.44	0.35	0.359									
8	1/2	12	3/4-16	7/8	1	7/8	22	0.391	0.391	0.66	0.66	0.31	0.42	0.125	1.44	1.25	0.31	0.750	0.44	0.35	0.510									
10	5/8	14 15 16	7/8-14	1	1 1/8	1	27	0.484	0.446	0.76	0.81	0.38	0.50	0.125	1.58	1.39	0.36	0.875	0.44	0.35	0.610									
12	3/4	18 20	1 1/16-12	1 1/4	1 3/8	1 1/4	32	0.610	0.578	0.86	0.91	0.36	0.56	0.125	1.75	1.56	0.41	1.063	0.44	0.35	0.753									
14	7/8	22	1 3/16-12	1 3/8	1 1/2	1 3/8	36	0.718	0.680	0.89	0.95	0.38	0.58	0.125	1.75	1.56	0.41	1.188	0.44	0.35	0.849									
16	1	25	1 5/16-12	1 1/2	1 5/8	1 1/2	38	0.844	0.769	0.91	0.99	0.34	0.59	0.125	1.75	1.56	0.41	1.313	0.44	0.35	0.940									
20	1 1/4	28 30 32	1 5/8-12	2	1 7/8	2	50	1.078	1.020	0.96	1.03	0.34	0.63	0.125	1.80	1.61	0.41	1.625	0.44	0.35	1.198									
24	1 1/2	35 38	1 7/8-12	2 1/4	2 1/8	2 1/4	60	1.312	1.230	1.08	1.16	0.50	0.73	0.125	1.81	1.62	0.41	1.875	0.31	0.22	1.416									
32	2	—	2 1/2-12	2 7/8	2 3/4	2 7/8	—	1.781	1.736	1.33	1.40	0.55	0.94	0.125	2.09	1.91	0.41	2.500	0.35	0.25	1.994									
40 ²⁾	2 1/2	—	3-12	3 3/8	—	—	—	2.281	—	—	—	0.55	—	0.125	1.72	1.72	0.41	2.998	0.45	0.45	—									

1) Recommended clearance hole = W + 0.015.

2) Not a standard SAE J514 size.

Dimensions and pressures for reference only, subject to change.



BTX

Nut
37° Flare

SAE 070110
HPD Base # 06B

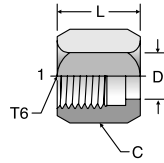

TUBE FITTING PART #	END SIZE		T6 UN/UNF-2B	C HEX (in.)	D (in.)	L (in.)	Material		
	(in.)	(mm)					-S	-SS	-B
2 BTX	1/8	—	5/16 - 24	3/8	0.180	0.55	•	•	•
3 BTX	3/16	—	3/8 - 24	7/16	0.240	0.61	•	•	•
4 BTX	1/4	6	7/16 - 20	9/16	0.310	0.62	•	•	•
5 BTX	5/16	8	1/2 - 20	5/8	0.380	0.68	•	•	•
6 BTX	3/8	10	9/16 - 18	11/16	0.440	0.73	•	•	•
8 BTX	1/2	12	3/4 - 16	7/8	0.570	0.85	•	•	•
10 BTX	5/8	14, 15, 16	7/8 - 14	1	0.700	0.98	•	•	•
12 BTX	3/4	18	1 1/16 - 12	1 1/4	0.840	1.03	•	•	•
20-12 BTX	—	20	1 1/16 - 12	1 1/4	0.862	0.87	•	•	•
14 BTX	7/8	—	1 3/16 - 12	1 3/8	0.960	1.09	•	•	•
16 BTX	1	25	1 5/16 - 12	1 1/2	1.090	1.13	•	•	•
20 BTX	1 1/4	28, 30, 32	1 5/8 - 12	2	1.350	1.23	•	•	•
24 BTX	1 1/2	35, 38	1 7/8 - 12	2 1/4	1.620	1.42	•	•	•
32 BTX	2	42, 50	2 1/2 - 12	2 7/8	2.170	1.75	•	•	•

Note: All stainless steel nuts are coated to prevent galling at assembly.

TX (inch)

Sleeve
37° Flare

SAE 070115
HPD Base # 06S

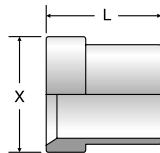

TUBE FITTING PART #	END SIZE (in.)	L (in.)	X (in.)	Material		
				-S	-SS	-B
2 TX	1/8	0.34	0.27	•	•	•
3 TX	3/16	0.34	0.33	•	•	•
4 TX	1/4	0.41	0.38	•	•	•
5 TX	5/16	0.44	0.45	•	•	•
6 TX	3/8	0.50	0.50	•	•	•
8 TX	1/2	0.56	0.68	•	•	•
10 TX	5/8	0.66	0.80	•	•	•
12 TX	3/4	0.69	0.97	•	•	•
14 TX	7/8	0.75	1.10	•	•	•
16 TX	1	0.78	1.22	•	•	•
20 TX	1 1/4	0.91	1.53	•	•	•
24 TX	1 1/2	1.13	1.78	•	•	•
32 TX	2	1.19	2.41	•	•	•

TX (metric)

Sleeve
37° Flare

SAE 070115

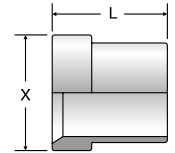

TUBE FITTING PART #	See Note	END SIZE (mm)	FITTING DASH SIZE	L (mm)	X (mm)	Material		
						-S	-SS	-B
TXS6	3	6	-4	10.4	9.6	•	•	•
5 TX	1	8	-5	11.2	11.4	•	•	•
TXS10	3	10	-6	12.7	12.7	•	•	•
TXS12	3	12	-8	14.2	17.3	•	•	•
TXS14	3	14	-10	16.8	20.3	•	•	•
TXS15	3	15	-10	16.8	20.3	•	•	•
10 TX	1	16	-10	16.8	20.3	•	•	•
TXS18	3	18	-12	17.3	24.6	•	•	•
20-12 TX	2	20	-12	17.3	24.6	•	•	•
TXS22	3	22	-14	19.0	27.8	•	•	•
TXS25	3	25	-16	19.8	31.0	•	•	•
TXS28	3	28	-20	23.1	38.9	•	•	•
TXS30	3	30	-20	23.1	38.9	•	•	•
TXS32	3	32	-20	23.1	38.9	•	•	•
TXS35	3	35	-24	28.4	45.2	•	•	•
24 TX	1	38	-24	28.4	45.2	•	•	•

1. Inch sleeve for use with metric tubing.
2. Use with 20-12 BTX.
3. The part numbers above are for steel. Use "SS" in place of "S" for ordering stainless steel. Example: TXSS12

Dimensions and pressures for reference only, subject to change.



WLN

Bulkhead Locknut

SAE 080118 and 070118
HPD Base # 53-XN

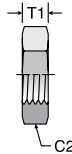

TUBE FITTING PART #	TUBE O.D. (in.)	C2 HEX (in.)	T1 (in.)	Material		
				-S	-SS	-B
3 WLN	3/16	5/8	0.22	•	•	•
4 WLN	1/4	11/16	0.28	•	•	•
5 WLN	5/16	3/4	0.28	•	•	•
6 WLN	3/8	13/16	0.27	•	•	•
8 WLN	1/2	1	0.31	•	•	•
10 WLN	5/8	1 1/8	0.36	•	•	•
12 WLN	3/4	1 3/8	0.41	•	•	•
14 WLN	7/8	1 1/2	0.41	•	•	•
16 WLN	1	1 5/8	0.41	•	•	•
20 WLN	1 1/4	1 7/8	0.41	•	•	•
24 WLN	1 1/2	2 1/8	0.41	•	•	•
32 WLN	2	2 3/4	0.41	•	•	•

HTX

Union
37° Flare / 37° Flare

SAE 070101
HPD Base # 0303

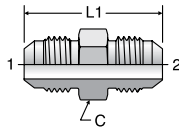

TUBE FITTING PART #	END SIZE		C HEX (in.)	L1 (in.)	Dynamic Pressure (x 1,000 PSI)			
	1 (in.)	2 (in.)			-S	-SS	-B	D
2 HTX	1/8	1/8	7/16	1.17	7.5	9.0	3.3	3.8
3 HTX	3/16	3/16	7/16	1.23	7.5	9.0	3.3	3.8
4 HTX	1/4	1/4	1/2	1.37	7.5	9.0	3.3	3.8
4-2 HTX	1/4	1/8	1/2	1.27	7.5	9.0	3.3	3.8
4-3 HTX	1/4	3/16	1/2	1.30	7.5	9.0	3.3	3.8
5 HTX	5/16	5/16	9/16	1.37	6.0	7.2	3.3	3.0
5-4 HTX	5/16	1/4	9/16	1.38	6.0	7.2	3.3	3.0
6 HTX	3/8	3/8	5/8	1.41	6.0	7.2	3.3	3.0
6-4 HTX	3/8	1/4	5/8	1.41	6.0	7.2	3.3	3.0
6-5 HTX	3/8	5/16	5/8	1.41	6.0	7.2	3.3	3.0
8 HTX	1/2	1/2	13/16	1.62	6.0	7.2	3.3	3.0
8-4 HTX	1/2	1/4	13/16	1.52	6.0	7.2	3.3	3.0
8-6 HTX	1/2	3/8	13/16	1.52	6.0	7.2	3.3	3.0
10 HTX	5/8	5/8	15/16	1.88	5.0	6.0	3.3	2.5
10-8 HTX	5/8	1/2	15/16	1.78	5.0	6.0	3.3	2.5
12 HTX	3/4	3/4	1 1/8	2.16	5.0	6.0	3.3	2.5
12-8 HTX	3/4	1/2	1 1/8	1.95	5.0	6.0	3.3	2.5
12-10 HTX	3/4	5/8	1 1/8	2.05	5.0	6.0	3.3	2.5
14 HTX	7/8	7/8	1 1/4	2.22	5.0	6.0	2.6	2.5
16 HTX	1	1	1 3/8	2.25	4.0	4.8	2.6	2.0
16-12 HTX	1	3/4	1 3/8	2.20	4.0	4.8	2.6	2.0
20 HTX	1 1/4	1 1/4	1 11/16	2.43	4.0	4.8	2.6	•
24 HTX	1 1/2	1 1/2	2	2.75	3.0	3.6	2.0	•
24-10 HTX	1 1/2	5/8	2	2.42	3.0	3.6	2.0	•
24-12 HTX	1 1/2	3/4	2	2.53	3.0	3.6	2.0	•
24-16 HTX	1 1/2	1	2	2.58	3.0	3.6	2.0	•
32 HTX	2	2	2 5/8	3.40	2.0	2.4	1.3	•
32-24 HTX	2	1 1/2	2 5/8	2.81	2.0	2.4	1.3	•

• Contact TFD

SBR

Braze Ring

SAE 080118 and 070118
HPD Base # 53-XN

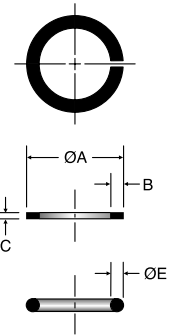

TUBE FITTING PART #	TUBE O.D. (in.)	A DIA. (in.)	B (in.)	C (in.)	E (in.)	Material		
						-S	-SS	-B
4SBR	1/4	0.260	—	—	0.05	•	•	•
6SBR	3/8	0.390	0.07	0.03	—	•	•	•
8SBR	1/2	0.515	0.07	0.03	—	•	•	•
10SBR	5/8	0.640	0.07	0.03	—	•	•	•
12SBR	3/4	0.765	0.08	0.04	—	•	•	•
14SBR	7/8	0.890	—	—	0.06	•	•	•
16SBR	1	1.015	0.08	0.04	—	•	•	•
20SBR	1 1/4	1.265	0.08	0.04	—	•	•	•
24SBR	1 1/2	1.515	0.08	0.04	—	•	•	•
32SBR	2	2.015	—	—	0.09	•	•	•

LHTX

Large Hex Union
37° Flare / 37° Flare

SAE 070119
HPD Base # 03L3

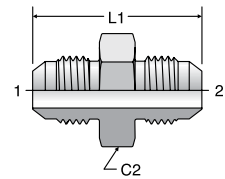

TUBE FITTING PART #	END SIZE		C2 HEX (in.)	L1 (in.)	Dynamic Pressure (x 1,000 PSI)		
	1 (in.)	2 (in.)			-S	-SS	-B
4 LHTX	1/4	1/4	11/16	1.38	7.5	9.0	3.3
4-3 LHTX	1/4	3/16	11/16	1.30	7.5	9.0	3.3
5 LHTX	5/16	5/16	3/4	1.37	6.0	7.2	3.3
6 LHTX	3/8	3/8	13/16	1.41	6.0	7.2	3.3
6-4 LHTX	3/8	1/4	13/16	1.41	6.0	7.2	3.3
8 LHTX	1/2	1/2	1	1.62	6.0	7.2	3.3
8-4 LHTX	1/2	1/4	1	1.52	6.0	7.2	3.3
8-6 LHTX	1/2	3/8	1	1.52	6.0	7.2	3.3
10 LHTX	5/8	5/8	1 1/8	1.88	5.0	6.0	3.3
12 LHTX	3/4	3/4	1 3/8	2.16	5.0	6.0	3.3
12-8 LHTX	3/4	1/2	1 3/8	1.95	5.0	6.0	3.3
16 LHTX	1	1	1 5/8	2.25	4.0	4.8	2.6
32 LHTX	2	2	2 3/4	3.40	2.0	2.4	1.3

Dimensions and pressures for reference only, subject to change.

WTX

Bulkhead Union
37° Flare / 37° Flare

SAE 070601
HPD Base # 0353
WTX-WLN – Body with locknut
(See page B10 for WLN)

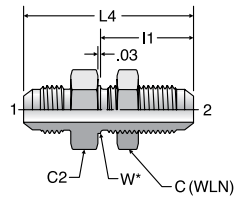

W* – Bulkhead pilot dia.
recommended clearance hole
+.015 over W dia.

WF5OX

ORB Bulkhead Connector
37° Flare / ORB

HPD Base # 0355
WF5OX-WLN – Body with locknut
(See page B10 for WLN)

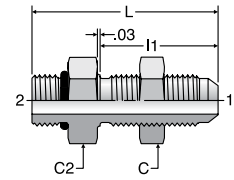

TUBE FITTING PART #	END SIZE		C HEX (in.)	C2 HEX (in.)	I1 (in.)	L4 (in.)	W DIA (in.)	MAX BULKHEAD WALL THICKNESS (in.)	Dynamic Pressure (x 1,000 PSI)		
	1 & 2 (in.)								-S	-SS	-B
3 WTX	3/16	5/8	5/8	1.11	1.90	0.38	0.38	7.5	9.0	3.3	
4 WTX	1/4	11/16	11/16	1.20	2.07	0.44	0.38	7.5	9.0	3.3	
5 WTX	5/16	3/4	3/4	1.20	2.07	0.50	0.38	6.0	7.2	3.3	
6 WTX	3/8	13/16	13/16	1.28	2.18	0.56	0.44	6.0	7.2	3.3	
8 WTX	1/2	1	1	1.44	2.44	0.75	0.44	6.0	7.2	3.3	
10 WTX	5/8	1 1/8	1 1/8	1.58	2.74	0.88	0.44	5.0	6.0	3.3	
12 WTX	3/4	1 3/8	1 3/8	1.75	3.09	1.06	0.44	5.0	6.0	3.3	
14 WTX	7/8	1 1/2	1 1/2	1.75	3.12	1.19	0.44	5.0	6.0	3.3	
16 WTX	1	1 5/8	1 5/8	1.75	3.14	1.31	0.44	4.0	4.8	2.6	
20 WTX	1 1/4	1 7/8	1 7/8	1.80	3.31	1.63	0.44	4.0	4.8	2.6	
24 WTX	1 1/2	2 1/8	2 1/8	1.81	3.52	1.88	0.31	3.0	3.6	2.0	
32 WTX	2	2 3/4	2 3/4	2.09	4.20	2.50	0.35	2.0	2.4	1.3	

TUBE FITTING PART #	END SIZE		C HEX (in.)	C2 HEX (in.)	I1 (in.)	L (in.)	MAX BULKHEAD WALL THICKNESS (in.)	Dynamic Pressure (x 1,000 PSI)		
	1 (in.)	2 UN/UNF-2A						-S	-SS	-B
4 WF5OX	1/4	7/16 - 20	11/16	11/16	1.20	1.84	0.38	7.5	9.0	3.3
6 WF5OX	3/8	9/16 - 18	13/16	13/16	1.28	2.02	0.44	6.0	7.2	3.3
8 WF5OX	1/2	3/4 - 16	1	1	1.44	2.19	0.44	6.0	7.2	3.3
10 WF5OX	5/8	7/8 - 14	1 1/8	1 1/8	1.58	2.47	0.44	5.0	6.0	3.3
12 WF5OX	3/4	1 1/16 - 12	1 3/8	1 3/8	1.75	2.79	0.44	5.0	6.0	3.3
16 WF5OX	1	1 5/16 - 12	1 5/8	1 5/8	1.75	2.90	0.44	4.5	5.4	2.9

WFTX

Male Bulkhead Connector
37° Flare / NPTF

HPD Base # 0153
WFTX-WLN – Body with locknut
(See page B10 for WLN)

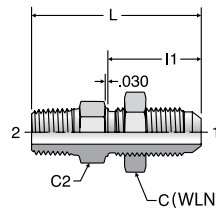

TUBE FITTING PART #	END SIZE		C HEX (in.)	C2 HEX (in.)	I1 (in.)	L (in.)	MAX BULKHEAD WALL THICKNESS (in.)	Dynamic Pressure (x 1,000 PSI)		
	1 (in.)	2 NPTF						-S	-SS	-B
4 WFTX	1/4	1/8 - 27	11/16	11/16	1.20	1.88	0.38	6.0	6.0	3.3
4-4 WFTX	1/4	1/4 - 18	11/16	11/16	1.20	2.10	0.38	6.0	6.0	3.3
6 WFTX	3/8	1/4 - 18	13/16	13/16	1.28	2.18	0.44	6.0	6.0	3.3
6-6 WFTX	3/8	3/8 - 18	13/16	13/16	1.28	2.16	0.44	6.0	6.0	3.3
6-8 WFTX	3/8	1/2 - 14	7/8	13/16	1.28	2.41	0.44	6.0	6.0	3.3
8 WFTX	1/2	3/8 - 18	1	1	1.44	2.34	0.44	6.0	6.0	3.3
8-8 WFTX	1/2	1/2 - 14	1	1	1.44	2.60	0.44	6.0	6.0	3.3
10 WFTX	5/8	1/2 - 14	1 1/8	1 1/8	1.58	2.74	0.44	5.0	5.0	3.3
12 WFTX	3/4	3/4 - 14	1 3/8	1 3/8	1.75	2.95	0.44	5.0	5.0	2.6
16 WFTX	1	1 - 11 1/2	1 5/8	1 5/8	1.75	3.14	0.44	4.5	4.5	2.0

Dimensions and pressures for reference only, subject to change.



WGTX

Female Bulkhead Connector
37° Flare / NPTF

HPD Base # 0253
WGTX-WLN – Body with locknut
(See page B10 for WLN)

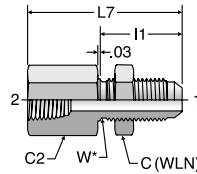

W* – Bulkhead pilot dia.
recommended clearance hole
+.015 over W dia.

TUBE FITTING PART #	END SIZE		C HEX (in.)	C2 HEX (in.)	I1 (in.)	L7 (in.)	W DIA (in.)	MAX BULKHEAD WALL THICKNESS (in.)	Dynamic Pressure (x 1,000 PSI)		
	1 (in.)	2 NPTF							-S	-SS	-B
4 WGTX	1/4	1/8 - 27	11/16	11/16	1.20	1.84	0.44	0.38	6.0	6.0	3.3
4-4 WGTX	1/4	1/4 - 18	11/16	3/4	1.20	2.11	0.44	0.38	6.0	6.0	3.3
6 WGTX	3/8	1/4 - 18	13/16	13/16	1.28	2.12	0.56	0.44	6.0	6.0	3.3
6-6 WGTX	3/8	3/8 - 18	13/16	7/8	1.28	2.24	0.56	0.44	6.0	6.0	3.3
8 WGTX	1/2	3/8 - 18	1	1	1.44	2.34	0.75	0.44	6.0	6.0	3.3
8-8 WGTX	1/2	1/2 - 14	1	1 1/8	1.44	2.61	0.75	0.44	5.0	5.0	3.3
10 WGTX	5/8	1/2 - 14	1 1/8	1 1/8	1.58	2.71	0.88	0.44	5.0	5.0	3.3
12 WGTX	3/4	3/4 - 14	1 3/8	1 3/8	1.75	2.95	1.06	0.44	4.0	4.0	2.6
14 WGTX	7/8	3/4 - 14	1 3/8	1 1/2	1.75	2.92	1.19	0.41	4.0	4.0	2.6
16 WGTX	1	1 - 11 1/2	1 5/8	1 5/8	1.75	3.19	1.31	0.44	3.0	3.0	2.0
24 WGTX	1 1/2	1 1/2-11 1/2	2 1/8	2 1/4	1.81	3.35	1.88	0.31	2.0	2.0	1.3

XHX6

Extender and Expander
37° Flare / 37° Flare Swivel

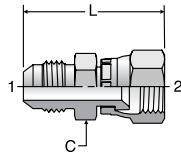

TUBE FITTING PART #	END SIZE		C HEX (in.)	L (in.)	Dynamic Pressure (x 1,000 PSI)		
	1 (in.)	2 (in.)			-S	-SS	-B
4 XHX6	1/4	1/4	9/16	1.39	7.5	7.7	3.3
6 XHX6	3/8	3/8	5/8	1.50	6.0	6.0	3.3
6-4 XHX6	3/8	1/4	5/8	1.50	6.0	6.0	3.3
8 XHX6	1/2	1/2	13/16	1.71	6.0	6.0	3.3
8-6 XHX6	1/2	3/8	13/16	1.72	6.0	6.0	3.3
10 XHX6	5/8	5/8	1	2.01	5.0	5.0	3.3
10-8 XHX6	5/8	1/2	15/16	1.93	5.0	5.0	3.3
12 XHX6	3/4	3/4	1 1/4	2.20	5.0	5.0	3.3
12-10 XHX6	3/4	5/8	1 1/8	2.19	5.0	5.0	3.3
16 XHX6	1	1	1 1/2	2.47	4.0	3.0	2.6
16-12 XHX6	1	3/4	1 1/2	2.24	4.0	3.0	2.6
20-16 XHX6	1 1/4	1	1 11/16	2.50	4.0	3.0	2.6

Dimensions and pressures for reference only, subject to change.

TRTX / TRTXN

Reducer
37° Flare

SAE 070123 / SAE 070123A
HPD Base # 0603 (TRTXN only)

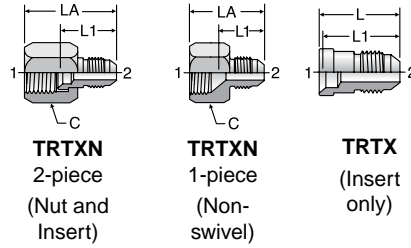

TUBE FITTING PART #			END SIZE		C HEX (in.)	L (TRTX) (in.)	LA (TRTXN) (in.)	L1 (TRTX & TRTXN) (in.)	Dynamic Pressure (x 1,000 PSI)		
TRTXN 2-pc. Design (with Large Nut)	TRTXN 1-pc. Design (Machined Female)	TRTX Reducer Insert (For 2-pc. Design Only)	1 (in.)	2 (in.)					-S	-SS	-B
4-2 TRTXN	-	4-2 TRTX	1/4	1/8	9/16	0.75	1.14	0.68	7.5	9.0	3.3
-	4-3 TRTXN	-	1/4	3/16	9/16	-	1.09	0.64	7.5	9.0	3.3
-	5-4 TRTXN	-	5/16	1/4	5/8	-	1.16	0.69	6.0	7.2	3.3
6-4 TRTXN	-	6-4 TRTX	3/8	1/4	11/16	0.97	1.40	0.90	6.0	7.2	3.3
-	6-5 TRTXN	-	3/8	5/16	11/16	-	1.19	0.73	6.0	7.2	3.3
8-4 TRTXN	-	8-4 TRTX	1/2	1/4	7/8	1.00	1.50	0.90	6.0	7.2	3.3
8-6 TRTXN	-	8-6 TRTX	1/2	3/8	7/8	1.00	1.50	0.90	6.0	7.2	3.3
10-4 TRTXN	-	10-4 TRTX	5/8	1/4	1	1.03	1.61	0.93	5.0	6.0	3.3
10-6 TRTXN	-	10-6 TRTX	5/8	3/8	1	1.03	1.61	0.93	5.0	6.0	3.3
-	10-8 TRTXN	-	5/8	1/2	1	-	1.48	0.85	5.0	6.0	3.3
12-4 TRTXN	-	12-4 TRTX	3/4	1/4	1 1/4	1.09	1.69	0.95	5.0	6.0	3.3
12-6 TRTXN	-	12-6 TRTX	3/4	3/8	1 1/4	1.09	1.69	0.95	5.0	6.0	3.3
12-8 TRTXN	-	12-8 TRTX	3/4	1/2	1 1/4	1.19	1.79	1.05	5.0	6.0	3.3
-	12-10 TRTXN	-	3/4	5/8	1 1/4	-	1.66	0.96	5.0	6.0	3.3
14-6 TRTXN	-	14-6 TRTX	7/8	3/8	1 3/8	1.13	1.78	1.00	5.0	6.0	3.3
14-10 TRTXN	-	14-10 TRTX	7/8	5/8	1 3/8	1.33	1.98	1.20	5.0	6.0	3.3
-	14-12 TRTXN	-	7/8	3/4	1 3/8	-	1.84	1.11	5.0	6.0	3.3
16-4 TRTXN	-	16-4 TRTX	1	1/4	1 1/2	1.22	1.90	1.09	4.5	5.4	2.9
16-6 TRTXN	-	16-6 TRTX	1	3/8	1 1/2	1.22	1.90	1.09	4.5	5.4	2.9
16-8 TRTXN	-	16-8 TRTX	1	1/2	1 1/2	1.27	1.95	1.14	4.5	5.4	2.9
16-10 TRTXN	-	16-10 TRTX	1	5/8	1 1/2	1.38	2.06	1.25	4.5	5.4	2.9
16-12 TRTXN	-	16-12 TRTX	1	3/4	1 1/2	1.47	2.15	1.34	4.5	5.4	2.9
-	16-14 TRTXN	-	1	7/8	1 1/2	-	1.91	1.15	4.5	5.4	2.9
-	-	20-8 TRTX	1 1/4	1/2	-	1.41	-	1.25	4.0	4.8	2.6
20-12 TRTXN	-	20-12 TRTX	1 1/4	3/4	2	1.53	2.17	1.37	4.0	4.8	2.6
20-16 TRTXN	-	20-16 TRTX	1 1/4	1	2	1.59	2.23	1.43	4.0	4.8	2.6
-	-	24-4 TRTX	1 1/2	1/4	-	1.47	-	1.32	3.0	3.6	2.0
24-8 TRTXN	-	24-8 TRTX	1 1/2	1/2	2 1/4	1.56	2.33	1.41	3.0	3.6	2.0
24-12 TRTXN	-	24-12 TRTX	1 1/2	3/4	2 1/4	1.63	2.40	1.48	3.0	3.6	2.0
24-16 TRTXN	-	24-16 TRTX	1 1/2	1	2 1/4	1.59	2.40	1.48	3.0	3.6	2.0
24-20 TRTXN	-	24-20 TRTX	1 1/2	1 1/4	2 1/4	1.69	2.46	1.54	3.0	3.6	2.0
-	-	32-12 TRTX	2	3/4	-	1.78	-	1.81	2.0	2.4	1.3
-	-	32-20 TRTX	2	1 1/4	-	1.78	-	1.59	2.0	2.4	1.3
32-24 TRTXN	-	32-24 TRTX	2	1 1/2	2 7/8	1.91	2.97	1.71	2.0	2.4	1.3

Dimensions and pressures for reference only, subject to change.

F50X

Straight Thread Connector
37° Flare / SAE-ORB

SAE 070120
HPD Base # 0503

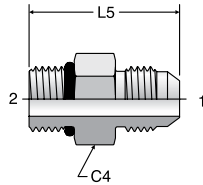

FF50X

Long Straight Thread Connector
37° Flare / SAE-ORB

SAE 071720
HPD Base # 053E

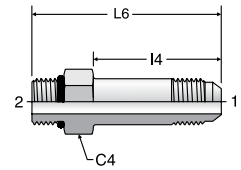

TUBE FITTING PART #	END SIZE		C4 HEX (in.)	L5 (in.)	Dynamic Pressure (x 1,000 PSI)			
	1 (in.)	2 UN/UNF-2A			-S	-SS	-B	D
2 F50X	1/8	5/16 - 24	7/16	1.06	7.5	9.0	3.3	3.8
3 F50X	3/16	3/8 - 24	1/2	1.10	7.5	9.0	3.3	3.8
3-2 F50X	3/16	5/16 - 24	1/2	1.10	7.5	9.0	3.3	3.8
4 F50X	1/4	7/16 - 20	9/16	1.23	7.5	9.0	3.3	3.8
4-2 F50X	1/4	5/16 - 24	9/16	1.17	7.5	9.0	3.3	3.8
4-3 F50X	1/4	3/8 - 24	9/16	1.19	7.5	9.0	3.3	3.8
4-5 F50X	1/4	1/2 - 20	5/8	1.23	6.0	7.2	3.3	3.0
4-6 F50X	1/4	9/16 - 18	11/16	1.29	6.0	7.2	3.3	3.0
4-8 F50X	1/4	3/4 - 16	7/8	1.38	6.0	7.2	3.3	3.0
4-10 F50X	1/4	7/8 - 14	1	1.49	5.0	6.0	3.3	2.5
5 F50X	5/16	1/2 - 20	5/8	1.23	6.0	7.2	3.3	3.0
5-4 F50X	5/16	7/16 - 20	9/16	1.23	6.0	7.2	3.3	3.0
5-6 F50X	5/16	9/16 - 18	11/16	1.30	6.0	7.2	3.3	3.0
5-8 F50X	5/16	3/4 - 16	7/8	1.37	6.0	7.2	3.3	3.0
6 F50X	3/8	9/16 - 18	11/16	1.30	6.0	7.2	3.3	3.0
6-4 F50X	3/8	7/16 - 20	5/8	1.27	6.0	7.2	3.3	3.0
6-5 F50X	3/8	1/2 - 20	5/8	1.27	6.0	7.2	3.3	3.0
6-8 F50X	3/8	3/4 - 16	7/8	1.38	6.0	7.2	3.3	3.0
6-10 F50X	3/8	7/8 - 14	1	1.50	5.0	6.0	3.3	2.5
6-12 F50X	3/8	1 1/16 - 12	1 1/4	1.66	5.0	6.0	3.3	2.5
8 F50X	1/2	3/4 - 16	7/8	1.48	6.0	7.2	3.3	3.0
8-4 F50X	1/2	7/16 - 20	13/16	1.50	6.0	7.2	3.3	3.0
8-6 F50X	1/2	9/16 - 18	13/16	1.44	6.0	7.2	3.3	3.0
8-10 F50X	1/2	7/8 - 14	1.00	1.60	5.0	6.0	3.3	2.5
8-12 F50X	1/2	1 1/16 - 12	1 1/4	1.76	5.0	6.0	3.3	2.5
8-16 F50X	1/2	1 5/16 - 12	1 1/2	1.78	4.5	5.4	2.9	2.3
10 F50X	5/8	7/8 - 14	1	1.70	5.0	6.0	3.3	2.5
10-6 F50X	5/8	9/16 - 18	11/16	1.71	5.0	6.0	3.3	2.5
10-8 F50X	5/8	3/4 - 16	15/16	1.64	5.0	6.0	3.3	2.5
10-12 F50X	5/8	1 1/16 - 12	1 1/4	1.86	5.0	6.0	3.3	2.5
10-16 F50X	5/8	1 5/16 - 12	1 1/2	1.89	4.5	5.4	2.9	2.5
12 F50X	3/4	1 1/16 - 12	1 1/4	1.97	5.0	6.0	3.3	2.5
12-8 F50X	3/4	3/4 - 16	1 1/8	1.94	5.0	6.0	3.3	2.5
12-10 F50X	3/4	7/8 - 14	1 1/8	1.88	5.0	6.0	3.3	2.5
12-14 F50X	3/4	1 3/16 - 12	1 3/8	1.96	5.0	6.0	3.3	2.5
12-16 F50X	3/4	1 5/16 - 12	1 1/2	1.99	4.5	5.4	2.9	2.3
12-20 F50X	3/4	1 5/8 - 12	1 7/8	2.08	4.0	4.8	2.6	•
14 F50X	7/8	1 3/16 - 12	1 3/8	1.99	5.0	6.0	3.3	2.5
14-16 F50X	7/8	1 5/16 - 12	1 1/2	2.02	4.5	5.4	2.9	2.3
16 F50X	1	1 5/16 - 12	1 1/2	2.04	4.5	5.4	2.9	2.3
16-8 F50X	1	3/4 - 16	1 3/8	1.78	4.5	5.4	2.9	2.3
16-10 F50X	1	7/8 - 14	1 3/8	2.08	4.5	5.4	2.9	2.3
16-12 F50X	1	1 1/16 - 12	1 3/8	1.99	4.5	5.4	2.9	2.3
16-14 F50X	1	1 3/16 - 12	1 3/8	2.05	4.5	5.4	2.9	2.3
16-20 F50X	1	1 5/8 - 12	1 7/8	2.12	4.0	4.8	2.6	•
16-24 F50X	1	1 7/8 - 12	2 1/8	2.20	3.0	3.6	2.0	•
20 F50X	1 1/4	1 5/8 - 12	1 7/8	2.17	4.0	4.8	2.6	•
20-12 F50X	1 1/4	1 1/16 - 12	1 11/16	2.30	4.0	4.8	2.6	•
20-16 F50X	1 1/4	1 5/16 - 12	1 11/16	2.33	4.0	4.8	2.6	•
20-24 F50X	1 1/4	1 7/8 - 12	2 1/8	2.24	3.0	3.6	2.0	•
24 F50X	1 1/2	1 7/8 - 12	2 1/8	2.38	3.0	3.6	2.0	•
24-20 F50X	1 1/2	1 5/8 - 12	2	2.53	3.0	3.6	2.0	•
24-32 F50X	1 1/2	2 1/2 - 12	2 3/4	2.53	2.0	2.4	1.3	•
32 F50X	2	2 1/2 - 12	2 3/4	2.78	2.0	2.4	1.3	•
32-24 F50X	2	1 7/8 - 12	2 5/8	2.94	2.0	2.4	1.3	•

TUBE FITTING PART #	END SIZE		C4 HEX (in.)	I4 (in.)	L6 (in.)	Dynamic Pressure (x 1,000 PSI)		
	1 (in.)	2 UN/UNF-2A				-S	-SS	-B
4 FF50X	1/4	7/16 - 20	9/16	1.39	2.08	7.5	9.0	3.3
4-6 FF50X	1/4	9/16 - 18	11/16	1.38	2.13	6.0	7.2	3.3
6 FF50X	3/8	9/16 - 18	11/16	1.56	2.31	6.0	7.2	3.3
8 FF50X	1/2	3/4 - 16	7/8	1.88	2.70	6.0	7.2	3.3
10 FF50X	5/8	7/8 - 14	1	2.09	3.04	5.0	6.0	3.3
12 FF50X	3/4	1 1/16 - 12	1 1/4	2.50	3.61	5.0	6.0	3.3
16 FF50X	1	1 5/16 - 12	1 1/2	2.84	3.98	4.5	5.4	2.9
20 FF50X	1 1/4	1 5/8 - 12	1 7/8	3.47	4.69	4.0	4.8	2.6

XHB3

Braze Socket
37° Flare / Inch Tube Braze

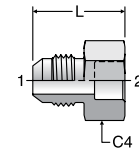

TUBE FITTING PART #	END SIZE		C4 HEX (in.)	L (in.)	Dynamic Pressure (x 1,000 PSI)		
	1 (in.)	2 (in.)			-S	-SS	-B
4 XHB3	1/4	1/4	9/16	0.97	7.5	7.5	3.3
6 XHB3	3/8	3/8	5/8	1.00	6.0	6.0	3.3
6-4 XHB3	3/8	1/4	5/8	1.00	6.0	6.0	3.3
6-8 XHB3	3/8	1/2	5/8	1.00	6.0	6.0	3.3
8 XHB3	1/2	1/2	13/16	1.12	6.0	6.0	3.3
8-10 XHB3	1/2	5/8	13/16	1.12	5.0	5.0	3.3
10 XHB3	5/8	5/8	15/16	1.21	5.0	5.0	3.3
10-8 XHB3	5/8	1/2	15/16	1.21	5.0	5.0	3.3
10-12 XHB3	5/8	3/4	1 1/8	1.37	5.0	5.0	3.3
12 XHB3	3/4	3/4	1 1/4	1.51	5.0	5.0	3.3
12-10 XHB3	3/4	5/8	1 1/8	1.51	5.0	5.0	3.3
12-16 XHB3	3/4	1	1 1/4	1.57	4.0	4.0	2.6
16 XHB3	1	1	1 3/8	1.63	4.0	4.0	2.6
16-20 XHB3	1	1 1/4	1 11/16	1.73	4.0	4.0	2.6
20 XHB3	1 1/4	1 1/4	1 11/16	1.71	4.0	4.0	2.6
20-24 XHB3	1 1/4	1 1/2	2	1.71	3.0	3.0	2.0
24 XHB3	1 1/2	1 1/2	2	1.84	3.0	3.0	2.0
32 XHB3	2	2	2 5/8	2.16	2.0	2.0	1.3

Note: Braze rings are on page B10.

Dimensions and pressures for reference only, subject to change.



FTX

Male Connector
37° Flare / NPTF

SAE 070102
HPD Base # 0103

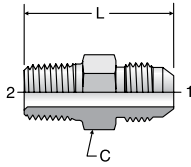

TUBE FITTING PART #	END SIZE		C HEX (in.)	L (in.)	Dynamic Pressure (x 1,000 PSI)			
	1 (in.)	2 NPTF			-S	-SS	-B	D
3 FTX	3/16	1/8 - 27	7/16	1.14	6.0	6.0	3.3	3.0
4 FTX	1/4	1/8 - 27	1/2	1.22	6.0	6.0	3.3	3.0
4-4 FTX	1/4	1/4 - 18	9/16	1.42	6.0	6.0	3.3	3.0
4-6 FTX	1/4	3/8 - 18	3/4	1.44	6.0	6.0	3.3	3.0
4-8 FTX	1/4	1/2 - 14	7/8	1.69	6.0	6.0	3.3	3.0
5 FTX	5/16	1/8 - 27	9/16	1.22	6.0	6.0	3.3	3.0
5-4 FTX	5/16	1/4 - 18	9/16	1.42	6.0	6.0	3.3	3.0
5-6 FTX	5/16	3/8 - 18	3/4	1.44	6.0	6.0	3.3	3.0
6 FTX	3/8	1/4 - 18	5/8	1.43	6.0	6.0	3.3	3.0
6-2 FTX	3/8	1/8 - 27	5/8	1.24	6.0	6.0	3.3	3.0
6-6 FTX	3/8	3/8 - 18	3/4	1.43	6.0	6.0	3.3	3.0
6-8 FTX	3/8	1/2 - 14	7/8	1.69	6.0	6.0	3.3	3.0
6-12 FTX	3/8	3/4 - 14	1 1/8	1.75	5.5	5.5	3.3	3.0
8 FTX	1/2	3/8 - 18	13/16	1.53	6.0	6.0	3.3	3.0
8-2 FTX	1/2	1/8 - 27	13/16	1.34	6.0	6.0	3.3	3.0
8-4 FTX	1/2	1/4 - 18	13/16	1.53	6.0	6.0	3.3	3.0
8-8 FTX	1/2	1/2 - 14	7/8	1.79	6.0	6.0	3.3	3.0
8-12 FTX	1/2	3/4 - 14	1 1/8	1.85	5.5	5.5	2.6	2.5
8-16 FTX	1/2	1 - 11 1/2	1 3/8	2.05	4.5	4.5	2.0	2.3
10 FTX	5/8	1/2 - 14	15/16	1.89	5.0	5.0	3.3	2.5
10-6 FTX	5/8	3/8 - 18	15/16	1.70	5.0	5.0	3.3	2.5
10-12 FTX	5/8	3/4 - 14	1 1/8	1.95	5.0	5.0	2.6	2.5
12 FTX	3/4	3/4 - 14	1 1/8	2.06	5.0	5.0	2.6	2.5
12-6 FTX	3/4	3/8 - 18	1 1/8	1.87	5.0	5.0	3.3	2.5
12-8 FTX	3/4	1/2 - 14	1 1/8	2.06	5.0	5.0	3.3	2.5
12-16 FTX	3/4	1 - 11 1/2	1 3/8	2.25	5.0	5.0	2.0	2.3
12-20 FTX	3/4	1 1/4 - 11 1/2	1 11/16	2.36	3.0	3.0	1.6	•
14 FTX	7/8	3/4 - 14	1 1/4	2.09	5.0	5.0	2.9	2.5
16 FTX	1	1 - 11 1/2	1 3/8	2.30	4.5	4.5	2.0	2.3
16-8 FTX	1	1/2 - 14	1 3/8	2.11	4.5	4.5	2.9	2.3
16-12 FTX	1	3/4 - 14	1 3/8	2.11	4.5	4.5	2.6	2.3
16-20 FTX	1	1 1/4 - 11 1/2	1 11/16	2.40	3.0	3.0	1.6	•
16-24 FTX	1	1 1/2 - 11 1/2	2	2.50	3.0	3.0	1.3	•
20 FTX	1 1/4	1 1/4 - 11 1/2	1 11/16	2.45	3.0	3.0	1.6	•
20-16 FTX	1 1/4	1 - 11 1/2	1 11/16	2.42	3.0	3.0	2.0	•
20-24 FTX	1 1/4	1 1/2 - 11 1/2	2	2.55	3.0	3.0	1.3	•
24 FTX	1 1/2	1 1/2 - 11 1/2	2	2.68	3.0	3.0	1.3	•
24-16 FTX	1 1/2	1 - 11 1/2	2	2.62	3.0	3.0	2.0	•
24-20 FTX	1 1/2	1 1/4 - 11 1/2	2	2.66	3.0	3.0	1.6	•
24-32 FTX	1 1/2	2 - 11 1/2	2 5/8	2.86	2.0	2.0	1.0	•
32 FTX	2	2 - 11 1/2	2 5/8	3.11	2.0	2.0	1.0	•
32-24 FTX	2	1 1/2 - 11 1/2	2 5/8	3.08	2.0	2.0	1.3	•
40 FTX	2 1/2	2 1/2 - 8	3 1/4	3.38	1.0	1.0	0.5	•

• Note: All "FTX" fittings include a 30° chamfer for sealing with NPSM swivel type fittings (steel only)

FFTX

Long Male Connector
37° Flare / NPTF

SAE 071802
HPD Base # 013E

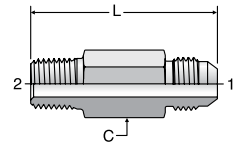

TUBE FITTING PART #	END SIZE		C (in.)	L (in.)	Dynamic Pressure (x 1,000 PSI)		
	1 (in.)	2 NPTF			-S	-SS	-B
4-4 FFTX	1/4	1/4 - 18	9/16	2.25	6.0	6.0	3.3
6 FFTX	3/8	1/4 - 18	5/8	2.25	6.0	6.0	3.3
6-6 FFTX	3/8	3/8 - 18	3/4	2.50	6.0	6.0	3.3
8 FFTX	1/2	3/8 - 18	13/16	2.75	6.0	6.0	3.3
8-8 FFTX	1/2	1/2 - 14	15/16	2.80	6.0	6.0	3.3
10 FFTX	5/8	1/2 - 14	15/16	3.12	5.0	5.0	3.3
12 FFTX	3/4	3/4 - 14	1 1/8	3.50	5.0	5.0	2.6

GTX

Female Connector
37° Flare / NPTF

SAE 070103
HPD Base # 0203

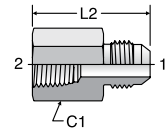

TUBE FITTING PART #	END SIZE		C1 HEX (in.)	L2 (in.)	Dynamic Pressure (x 1,000 PSI)		
	1 (in.)	2 NPTF			-S	-SS	-B
3 GTX	3/16	1/8 - 27	9/16	1.13	6.0	6.0	3.3
4 GTX	1/4	1/8 - 27	9/16	1.19	6.0	6.0	3.3
4-4 GTX	1/4	1/4 - 18	3/4	1.39	6.0	6.0	3.3
4-6 GTX	1/4	3/8 - 18	7/8	1.45	6.0	6.0	3.3
4-8 GTX	1/4	1/2 - 14	1 1/8	1.68	6.0	6.0	3.3
5 GTX	5/16	1/8 - 27	9/16	1.17	6.0	6.0	3.3
5-4 GTX	5/16	1/4 - 18	3/4	1.39	6.0	6.0	3.3
6 GTX	3/8	1/4 - 18	3/4	1.40	6.0	6.0	3.3
6-2 GTX	3/8	1/8 - 27	5/8	1.19	6.0	6.0	3.3
6-6 GTX	3/8	3/8 - 18	7/8	1.46	6.0	6.0	3.3
6-8 GTX	3/8	1/2 - 14	1 1/8	1.69	5.0	5.0	3.3
8 GTX	1/2	3/8 - 18	7/8	1.56	6.0	6.0	3.3
8-4 GTX	1/2	1/4 - 18	13/16	1.55	6.0	6.0	3.3
8-8 GTX	1/2	1/2 - 14	1 1/8	1.79	5.0	5.0	3.3
8-12 GTX	1/2	3/4 - 14	1 3/8	1.85	4.0	4.0	2.6
10 GTX	5/8	1/2 - 14	1 1/8	1.89	5.0	5.0	3.3
10-12 GTX	5/8	3/4 - 14	1 3/8	1.95	4.0	4.0	2.6
12 GTX	3/4	3/4 - 14	1 3/8	2.06	4.0	4.0	2.6
12-8 GTX	3/4	1/2 - 14	1 1/8	2.05	5.0	5.0	2.6
12-16 GTX	3/4	1 - 11 1/2	1 5/8	2.30	3.0	3.0	2.0
14 GTX	7/8	3/4 - 14	1 3/8	2.06	4.0	4.0	2.6
16 GTX	1	1 - 11 1/2	1 5/8	2.35	3.0	3.0	2.0
16-12 GTX	1	3/4 - 14	1 3/8	2.13	4.0	4.0	2.6
16-20 GTX	1	1 1/4 - 11 1/2	2	2.44	2.5	2.5	1.6
20 GTX	1 1/4	1 1/4 - 11 1/2	2	2.49	2.5	2.5	1.6
20-16 GTX	1 1/4	1 - 11 1/2	1 3/4	2.47	3.0	3.0	2.0
24 GTX	1 1/2	1 1/2 - 11 1/2	2 3/8	2.62	2.0	2.0	1.3
32 GTX	2	2 - 11 1/2	2 7/8	2.97	1.5	1.5	1.0

Dimensions and pressures for reference only, subject to change.



F87OMX

Male Connector – ISO 6149
37° Flare / ISO 6149

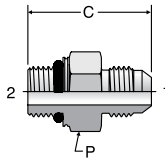

TUBE FITTING PART #	END SIZE		Male Metric Parallel Thread	C (mm)	P (mm)	Dynamic Pressure (x 1,000 PSI)		
	1					-S	-SS	-B
	(mm)	(in.)						
4M10F87OMX	6	1/4	M10x1	30.0	14	7.2	5.0	3.3
5M12F87OMX	8	5/16	M12x1.5	33.1	19	6.0	5.0	3.3
6M14F87OMX	10	3/8	M14x1.5	34.1	19	6.0	5.0	3.3
6M16F87OMX	10	3/8	M16x1.5	35.5	22	6.0	5.0	3.3
8M16F87OMX	12	1/2	M16x1.5	38.0	22	6.0	5.0	3.3
8M18F87OMX	12	1/2	M18x1.5	39.1	24	5.0	5.0	3.3
10M18F87OMX	14, 15, 16	5/8	M18x1.5	43.1	24	5.0	5.0	3.3
10M22F87OMX	14, 15, 16	5/8	M22x1.5	43.5	27	5.0	5.0	3.3
12M22F87OMX	18, 20	3/4	M22x1.5	48.0	27	5.0	5.0	3.3
12M27F87OMX	18, 20	3/4	M27x2	50.9	32	5.0	5.0	3.3
16M27F87OMX	25	1	M27x2	50.5	36	5.0	5.0	3.3
16M33F87OMX	25	1	M33x2	52.7	41	4.0	4.0	2.6
20M42F87OMX	30, 32	1 1/4	M42x2	55.0	50	4.0	3.0	2.0
24M48F87OMX	38	1 1/2	M48x2	59.4	55	3.0	2.0	1.3

F82EDMX

Male Connector – Metric
37° Flare / Metric-ED

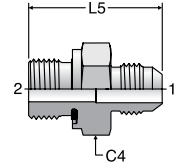

TUBE FITTING PART #	END SIZE		Male Metric Parallel Thread	C4 (mm)	L5 (mm)	Dynamic Pressure (x 1,000 PSI)		
	1					-S	-SS	-B
	(mm)	(in.)						
4M10F82EDMX	6	1/4	M10x1	14	30.0	7.2	5.0	3.3
5M12F82EDMX	8	5/16	M12x1.5	17	34.0	6.0	5.0	3.3
6M14F82EDMX	10	3/8	M14x1.5	19	35.0	6.0	5.0	3.3
6M16F82EDMX	10	3/8	M16x1.5	22	36.0	6.0	5.0	3.3
8M16F82EDMX	12	1/2	M16x1.5	22	38.5	6.0	5.0	3.3
8M18F82EDMX	12	1/2	M18x1.5	24	38.5	5.0	5.0	3.3
10M18F82EDMX	14, 15, 16	5/8	M18x1.5	24	42.5	5.0	5.0	3.3
10M22F82EDMX	14, 15, 16	5/8	M22x1.5	27	44.5	5.0	5.0	3.3
12M22F82EDMX	18, 20	3/4	M22x1.5	27	49.0	5.0	5.0	3.3
12M27F82EDMX	18, 20	3/4	M27x2	32	51.0	5.0	5.0	3.3
16M33F82EDMX	25	1	M33x2	41	54.5	4.0	4.0	2.6
20M42F82EDMX	30, 32	1 1/4	M42x2	50	60.0	4.0	3.0	2.0

F80MX

Male Connector – Metric
37° Flare / Metric-ORR

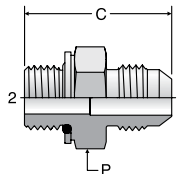

TUBE FITTING PART #	END SIZE		Male Metric Parallel Thread	C (mm)	P (mm)	Dynamic Pressure (x 1,000 PSI)		
	1					-S	-SS	-B
	(mm)	(in.)						
4M10F80MX	6	1/4	M10x1	30.0	14	5.0	5.0	3.3
5M12F80MX	8	5/16	M12x1.5	33.1	19	6.0	6.0	3.3
6M14F80MX	10	3/8	M14x1.5	34.1	19	5.0	5.0	3.3
8M16F80MX	12	1/2	M16x1.5	38.0	22	5.0	5.0	3.3
8M18F80MX	12	1/2	M18x1.5	39.1	24	3.6	3.6	2.3
10M18F80MX	14, 15, 16	5/8	M18x1.5	43.1	24	3.6	3.6	2.3
10M22F80MX	14, 15, 16	5/8	M22x1.5	43.5	27	3.6	3.6	2.3
12M22F80MX	18, 20	3/4	M22x1.5	48.0	27	3.6	3.6	2.3
12M24F80MX	18, 20	3/4	M24x1.5	44.5	30	3.0	3.0	2.0
12M27F80MX	18, 20	3/4	M27x2	50.9	32	3.0	3.0	2.0
16M27F80MX	25	1	M27x2	50.5	36	3.0	3.0	2.0
16M33F80MX	25	1	M33x2	52.7	41	3.0	3.0	2.0
20M42F80MX	30, 32	1 1/4	M42x2	54.9	50	3.0	3.0	2.0
24M48F80MX	38	1 1/2	M48x2	59.4	55	2.0	2.0	1.3

Note: If F80MX is not available, use F82EDMX.

F42EDMX

Male Connector – BSPP
37° Flare / BSPP-ED

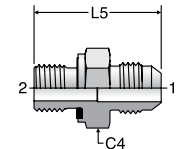

TUBE FITTING PART #	END SIZE			C4 (mm)	L5 (mm)	Dynamic Pressure (x 1,000 PSI)		
	1		2 BSPP			S	SS	B
	(mm)	(in.)						
4F42EDMX	6	1/4	1/8 - 28	14	30.2	7.2	5.0	3.3
4-4F42EDMX	6	1/4	1/4 - 19	19	35.0	6.0	5.0	3.3
4-6F42EDMX	6	1/4	3/8 - 19	22	36.0	6.0	5.0	3.3
4-8F42EDMX	6	1/4	1/2 - 14	27	39.5	5.0	5.0	3.3
5F42EDMX	8	5/16	1/8 - 28	14	30.0	6.0	5.0	3.3
5-4F42EDMX	8	5/16	1/4 - 19	19	35.0	6.0	5.0	3.3
5-6F42EDMX	8	5/16	3/8 - 19	22	36.0	6.0	5.0	3.3
6-2F42EDMX	10	3/8	1/8 - 28	17	31.2	6.0	5.0	3.3
6F42EDMX	10	3/8	1/4 - 19	19	35.0	6.0	5.0	3.3
6-6F42EDMX	10	3/8	3/8 - 19	22	36.0	6.0	5.0	3.3
6-8F42EDMX	10	3/8	1/2 - 14	27	39.5	5.0	5.0	3.3
8F42EDMX	12	1/2	3/8 - 19	22	38.6	6.0	5.0	3.3
8-4F42EDMX	12	1/2	1/4 - 19	19	39.0	6.0	5.0	3.3
8-8F42EDMX	12	1/2	1/2 - 14	27	42.0	5.0	5.0	3.3
8-12F42EDMX	12	1/2	3/4 - 14	32	45.7	5.0	5.0	3.3
10F42EDMX	14, 15, 16	5/8	1/2 - 14	27	45.0	5.0	5.0	3.3
10-6F42EDMX	14, 15, 16	5/8	3/8 - 19	24	43.0	5.0	5.0	3.3
10-12F42EDMX	14, 15, 16	5/8	3/4 - 14	32	48.2	5.0	5.0	3.3
12F42EDMX	18, 20	3/4	3/4 - 14	32	51.0	5.0	5.0	3.3
12-6F42EDMX	18, 20	3/4	3/8 - 19	27	50.0	5.0	5.0	3.3
12-8F42EDMX	18, 20	3/4	1/2 - 14	27	49.0	5.0	5.0	3.3
12-16F42EDMX	18, 20	3/4	1 - 11	41	53.5	4.0	4.0	2.6
16F42EDMX	25	1	1 - 11	41	55.0	4.0	4.0	2.6
16-12F42EDMX	25	1	3/4 - 14	36	53.0	4.0	4.0	2.6
16-20F42EDMX	25	1	1 1/4 - 11	50	59.0	4.0	4.0	2.6
20-16F42EDMX	30, 32	1 1/4	1 - 11	46	62.0	4.0	3.0	2.0
20F42EDMX	30, 32	1 1/4	1 1/4 - 11	50	60.0	4.0	3.0	2.0
20-24F42EDMX	30, 32	1 1/4	1 1/2 - 11	55	64.0	3.0	2.0	1.3
24F42EDMX	38	1 1/2	1 1/2 - 11	55	67.0	3.0	2.0	1.3
24-20F42EDMX	38	1 1/2	1 1/4 - 11	50	62.0	3.0	3.0	2.0

Dimensions and pressures for reference only, subject to change.



F4OMX

Male Connector – BSPP
37° Flare / BSPP-ORR

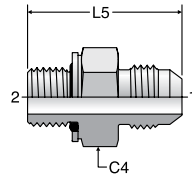

TUBE FITTING PART #	END SIZE			C4 (mm)	L5 (mm)	Dynamic Pressure (x 1,000 PSI)		
	1		2 BSPP			-S	-SS	-B
	(mm)	(in.)						
4F4OMX	6	1/4	1/8 - 28	17	28.3	5.0	5.0	3.3
4-4F4OMX	6	1/4	1/4 - 19	19	32.2	5.0	5.0	3.3
4-6F4OMX	6	1/4	3/8 - 19	22	33.1	5.0	5.0	3.3
4-8F4OMX	6	1/4	1/2 - 14	30	38.6	5.0	5.0	3.3
5-4F4OMX	8	5/16	1/4 - 19	19	32.2	5.0	5.0	3.3
5-6F4OMX	8	5/16	3/8 - 19	22	33.1	5.0	5.0	3.3
6F4OMX	10	3/8	1/4 - 19	19	32.5	5.0	5.0	3.3
6-6F4OMX	10	3/8	3/8 - 19	22	33.4	5.0	5.0	3.3
6-8F4OMX	10	3/8	1/2 - 14	30	38.0	5.0	5.0	3.3
8-4F4OMX	12	1/2	1/4 - 19	19	35.0	5.0	5.0	3.3
8F4OMX	12	1/2	3/8 - 19	22	35.9	5.0	5.0	3.3
8-8F4OMX	12	1/2	1/2 - 14	30	41.4	5.0	5.0	3.3
8-12F4OMX	12	1/2	3/4 - 14	36	42.2	4.0	4.0	2.6
10-6F4OMX	14, 15, 16	5/8	3/8 - 19	24	39.1	5.0	5.0	3.3
10F4OMX	14, 15, 16	5/8	1/2 - 14	30	43.1	5.0	5.0	3.3
12-8F4OMX	18, 20	3/4	1/2 - 14	30	46.7	5.0	5.0	3.3
12F4OMX	18, 20	3/4	3/4 - 14	36	47.5	4.0	3.6	2.3
12-16F4OMX	18, 20	3/4	1 - 11	46	52.6	4.0	3.6	2.3
16-12F4OMX	25	1	3/4 - 14	36	48.5	4.0	3.6	2.3
16F4OMX	25	1	1 - 11	46	53.6	4.0	3.6	2.3
16-20F4OMX	25	1	1 1/4 - 11	50	54.7	3.6	2.5	1.6
20F4OMX	30, 32	1 1/4	1 1/4 - 11	50	56.0	3.6	2.5	1.6
24-20F4OMX	38	1 1/2	1 1/4 - 11	50	60.4	3.0	2.0	1.3
24F4OMX	38	1 1/2	1 1/2 - 11	55	61.1	3.0	2.0	1.3

Note: If F4OMX is not available, use F42EDMX.

F3MX

Male Connector – BSPT
37° Flare / BSPT

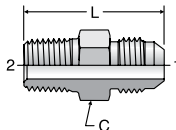

TUBE FITTING PART #	END SIZE			C HEX (mm)	L (mm)	Dynamic Pressure (x 1,000 PSI)		
	1		2 BSPT			-S	-SS	-B
	(mm)	(in.)						
4F3MX	6	1/4	1/8 - 28	13	30.7	4.5	4.5	2.9
4-4F3MX	6	1/4	1/4 - 19	14	35.3	4.5	4.5	2.9
5F3MX	8	5/16	1/8 - 28	14	30.7	4.5	4.5	2.9
5-4F3MX	8	5/16	1/4 - 19	14	35.3	4.5	4.5	2.9
6F3MX	10	3/8	1/4 - 19	17	35.6	4.5	4.5	2.9
6-6F3MX	10	3/8	3/8 - 19	19	36.4	4.5	4.5	2.9
6-8F3MX	10	3/8	1/2 - 14	22	42.9	4.5	4.5	2.9
8-4F3MX	12	1/2	1/4 - 19	19	38.1	4.5	4.5	2.9
8F3MX	12	1/2	3/8 - 19	19	38.9	4.5	4.5	2.9
8-8F3MX	12	1/2	1/2 - 14	22	45.5	4.5	4.5	2.9
10-6F3MX	14, 15, 16	5/8	3/8 - 19	24	43.2	4.5	4.5	2.9
10F3MX	14, 15, 16	5/8	1/2 - 14	24	48.0	4.5	4.5	2.9
10-12F3MX	14, 15, 16	5/8	3/4 - 14	27	48.3	2.3	2.3	1.5
12-8F3MX	18, 20	3/4	1/2 - 14	27	50.8	4.5	4.5	2.9
12F3MX	18, 20	3/4	3/4 - 14	27	50.8	2.3	2.3	1.5
12-16F3MX	18, 20	3/4	1 - 11	36	57.1	2.3	2.3	1.5
16-12F3MX	25	1	3/4 - 14	36	53.6	2.3	2.3	1.5
16F3MX	25	1	1 - 11	36	58.5	2.3	2.3	1.5
20-16F3MX	30, 32	1 1/4	1 - 11	46	61.4	2.3	2.3	1.5
20F3MX	30, 32	1 1/4	1 1/4 - 11	46	62.2	2.3	2.3	1.5
24F3MX	38	1 1/4	1 1/2 - 11	50	68.1	2.3	2.0	1.3

Dimensions and pressures for reference only, subject to change.

G4MX

Female Connector – BSPP
37° Flare / BSPP

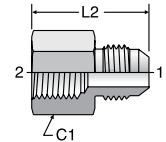

TUBE FITTING PART #	END SIZE			C1 (mm)	L2 (mm)	Dynamic Pressure (x 1,000 PSI)		
	1		2 BSPP			-S	-SS	-B
	(mm)	(in.)						
4G4MX	6	1/4	1/8 - 28	17	30.2	4.5	4.5	2.9
4-4G4MX	6	1/4	1/4 - 19	19	35.3	5.8	5.8	3.3
5G4MX	8	5/16	1/8 - 28	17	29.7	4.5	4.5	2.9
6G4MX	10	3/8	1/4 - 19	19	35.6	5.8	5.8	3.3
6-6G4MX	10	3/8	3/8 - 19	22	37.1	5.0	5.0	3.3
8G4MX	12	1/2	3/8 - 19	22	39.6	5.0	5.0	3.3
8-8G4MX	12	1/2	1/2 - 14	30	45.5	5.0	5.0	3.3
10G4MX	14, 15, 16	5/8	1/2 - 14	30	48.0	5.0	5.0	3.3
12G4MX	18, 20	3/4	3/4 - 14	36	52.3	4.5	4.5	2.9
16G4MX	25	1	1 - 11	46	59.7	4.0	4.0	2.6

HX6

Swivel Nut Union
37° Swivel / 37° Swivel

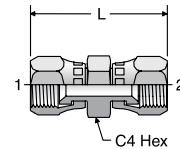

HPD Base # 0606

TUBE FITTING PART #	END SIZE		C4 HEX (in.)	L (in.)	Dynamic Pressure (x 1,000 PSI)		
	1 & 2 (in.)				-S	-SS	-B
	4 HX6	1/4					
6 HX6	3/8	11/16	1.75	6.0	6.0	3.3	
8 HX6	1/2	7/8	2.02	6.0	6.0	3.3	
10 HX6	5/8	1	2.24	5.0	5.0	3.3	
12 HX6	3/4	1 1/4	2.31	5.0	5.0	3.3	
16 HX6	1	1 1/2	2.75	4.0	3.0	2.6	



F650X

Swivel Straight Thread Connector
37° Swivel / SAE-ORB

HPD Base # 0506

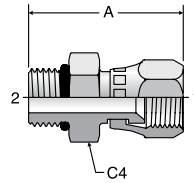

TUBE FITTING PART #	END SIZE		A (in.)	C4 HEX (in.)	Dynamic Pressure (x 1,000 PSI)		
	1 (in.)	2 UN/UNF-2A			-S	-SS	-B
4 F650X	1/4	7/16 - 20	1.31	9/16	7.5	7.5	3.3
4-6 F650X	1/4	9/16 - 18	1.33	11/16	6.0	7.2	3.3
5 F650X	5/16	1/2 - 20	1.39	5/8	6.0	7.2	3.3
6 F650X	3/8	9/16 - 18	1.43	11/16	6.0	7.2	3.3
6-4 F650X	3/8	7/16 - 20	1.37	9/16	6.0	7.2	3.3
6-8 F650X	3/8	3/4 - 16	1.50	7/8	6.0	7.2	3.3
8 F650X	1/2	3/4 - 16	1.61	7/8	6.0	7.2	3.3
8-6 F650X	1/2	9/16 - 18	1.54	13/16	6.0	7.2	3.3
8-10 F650X	1/2	7/8 - 14	1.78	1	5.0	6.0	3.3
10 F650X	5/8	7/8 - 14	1.81	1	5.0	6.0	3.3
10-8 F650X	5/8	3/4 - 16	1.75	1	5.0	6.0	3.3
10-12 F650X	5/8	1 1/16 - 12	1.85	1 1/4	5.0	6.0	3.3
12 F650X	3/4	1 1/16 - 12	2.07	1 1/4	5.0	6.0	3.3
12-10 F650X	3/4	7/8 - 14	2.10	1 1/4	5.0	6.0	3.3
12-16 F650X	3/4	1 5/16 - 12	2.04	1 1/2	4.5	4.5	2.9
16 F650X	1	1 5/16 - 12	2.14	1 1/2	4.0	3.0	2.6
16-12 F650X	1	1 1/16 - 12	2.14	1 1/2	4.0	3.0	2.6
20 F650X	1 1/4	1 5/8 - 12	2.55	2	4.0	3.0	2.6

F6X

Swivel Connector
37° Swivel / NPTF

HPD Base # 0106

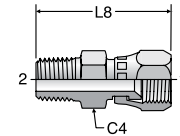

TUBE FITTING PART #	END SIZE		C4 (in.)	L8 (in.)	Dynamic Pressure (x 1,000 PSI)		
	1 (in.)	2 NPTF			-S	-SS	-B
4 F6X	1/4	1/8 - 27	9/16	1.21	6.0	6.0	3.3
4-4 F6X	1/4	1/4 - 18	9/16	1.54	6.0	6.0	3.3
5-4 F6X	5/16	1/4 - 18	5/8	1.60	6.0	6.0	3.3
6 F6X	3/8	1/4 - 18	11/16	1.66	5.0	5.0	3.3
6-6 F6X	3/8	3/8 - 18	3/4	1.69	5.0	5.0	3.3
8 F6X	1/2	3/8 - 18	7/8	1.74	5.0	5.0	3.3
8-8 F6X	1/2	1/2 - 14	7/8	1.97	5.0	5.0	3.3
10 F6X	5/8	1/2 - 14	1	2.05	5.0	5.0	3.3
10-6 F6X	5/8	3/8 - 18	1	1.84	5.0	5.0	3.3
12 F6X	3/4	3/4 - 14	1 1/4	2.15	5.0	5.0	3.3
12-8 F6X	3/4	1/2 - 14	1 1/4	2.15	5.0	5.0	3.3
16 F6X	1	1 - 11 1/2	1 1/2	2.50	3.6	3.6	2.3
16-12 F6X	1	3/4 - 14	1 1/2	2.33	3.6	3.6	2.3
20 F6X	1 1/4	1 1/4 - 11 1/2	2	2.76	3.0	3.0	2.0
24 F6X	1 1/2	1 1/2 - 11 1/2	2 1/4	3.05	2.5	2.5	1.6
32 F6X	2	2 - 11 1/2	2 5/8	3.53	2.0	2.0	1.3

G6X

Swivel Nut Female Connector
37° Swivel / NPTF

HPD Base # 0206

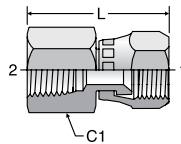

TUBE FITTING PART #	END SIZE		C1 (in.)	L (in.)	Dynamic Pressure (x 1,000 PSI)		
	1 (in.)	2 NPTF			-S	-SS	-B
4 G6X	1/4	1/8 - 27	9/16	1.27	6.0	6.0	3.3
4-4 G6X	1/4	1/4 - 18	3/4	1.43	6.0	6.0	3.3
6 G6X	3/8	1/4 - 18	3/4	1.44	5.0	5.0	3.3
6-6 G6X	3/8	3/8 - 18	7/8	1.54	5.0	5.0	3.3
6-8 G6X	3/8	1/2 - 14	1 1/8	1.80	5.0	5.0	3.3
8 G6X	1/2	3/8 - 18	7/8	1.69	5.0	5.0	3.3
8-8 G6X	1/2	1/2 - 14	1 1/8	1.94	5.0	5.0	3.3
10 G6X	5/8	1/2 - 14	1 1/8	1.98	5.0	5.0	3.3
12 G6X	3/4	3/4 - 14	1 3/8	2.01	4.0	4.0	2.6
12-8 G6X	3/4	1/2 - 14	1 1/4	2.00	5.0	5.0	3.3
16 G6X	1	1 - 11 1/2	1 5/8	2.48	3.0	3.0	2.0
20 G6X	1 1/4	1 1/4 - 11 1/2	2	2.86	2.5	2.5	1.6
24 G6X	1 1/2	1 1/2 - 11 1/2	2 3/8	3.01	2.0	2.0	1.3
32 G6X	2	2 - 11 1/2	2 7/8	3.40	1.5	1.5	1.0

F6870MX

Swivel - ISO 6149 Connector
37° Swivel / ISO 6149

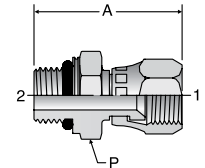

TUBE FITTING PART #	END SIZE		A (mm)	P (mm)	Dynamic Pressure (x 1,000 PSI)		
	1 (mm)	2 (in.) Male Metric Parallel Thread			-S	-SS	-B
4M10F6870MX	6	1/4 M10x1	31.9	14	7.2	5.0	3.3
5M12F6870MX	8	5/16 M12x1.5	35.6	17	6.0	5.0	3.3
6M14F6870MX	10	3/8 M14x1.5	37.2	19	5.0	5.0	3.3
8M16F6870MX	12	1/2 M16x1.5	41.8	22	5.0	5.0	3.3
10M22F6870MX	14, 15, 16	5/8 M22x1.5	47.6	27	5.0	5.0	3.3
12M27F6870MX	18, 20	3/4 M27x2	51.7	32	5.0	5.0	3.3
16M33F6870MX	25	1 M33x2	56.9	41	3.6	3.6	2.3

Dimensions and pressures for reference only, subject to change.



F68OMX

Swivel Metric ORR Connector
Metric-ORR / 37° Swivel

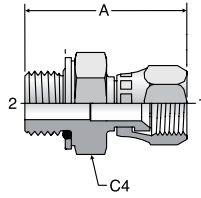

TUBE FITTING PART #	END SIZE			A (mm)	C4 (mm)	Dynamic Pressure (x 1,000 PSI)		
	1		Male Metric Parallel Thread			-S	-SS	-B
	(mm)	(in.)						
4M10F68OMX	6	1/4	M10x1	30.2	14	5.0	5.0	3.3
5M12F68OMX	8	5/16	M12x1.5	35.6	17	6.0	6.0	3.3
6M14F68OMX	10	3/8	M14x1.5	37.2	19	5.0	5.0	3.3
8M16F68OMX	12	1/2	M16x1.5	42.4	22	3.6	3.6	2.3
10M22F68OMX	14, 15, 16	5/8	M22x1.5	47.9	27	3.6	3.6	2.3
12M27F68OMX	18, 20	3/4	M27x2	52.3	32	3.0	3.0	2.0
16M33F68OMX	25	1	M33x2	57.4	41	3.0	3.0	2.0

F682EDMX

Metric-ED / 37° Swivel

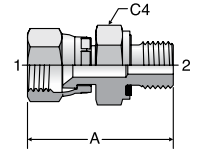

TUBE FITTING PART #	END SIZE			A (mm)	C4 (mm)	Dynamic Pressure (x 1,000 PSI)		
	1		Male Metric Parallel Thread			-S	-SS	-B
	(mm)	(in.)						
4M10F682EDMX	6	1/4	M10x1	29.7	14	7.2	5.0	3.3
5M12F682EDMX	8	5/16	M12x1.5	36.6	17	6.0	5.0	3.3
6M14F682EDMX	10	3/8	M14x1.5	38.2	19	5.0	5.0	3.3
8M16F682EDMX	12	1/2	M16x1.5	42.3	22	5.0	5.0	3.3
10M22F682EDMX	14, 15, 16	5/8	M22x1.5	48.6	27	5.0	5.0	3.3
12M27F682EDMX	18, 20	3/4	M27x2	51.7	32	5.0	5.0	3.3
16M33F682EDMX	25	1	M33x2	59.0	41	3.6	3.6	2.3

F642EDMX

Swivel – BSPP Connector
37° Swivel / BSPP-ED

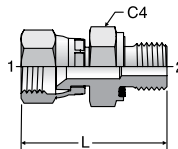

TUBE FITTING PART #	END SIZE			C4 (mm)	L (mm)	Dynamic Pressure (x 1,000 PSI)		
	1		2 BSPP			-S	-SS	-B
	(mm)	(in.)						
4F642EDMX	6	1/4	1/8 - 28	14	29.7	7.2	5.0	3.3
4-4F642EDMX	6	1/4	1/4 - 19	19	35.2	6.0	5.0	3.3
5F642EDMX	8	5/16	1/8 - 28	14	32.8	6.0	5.0	3.3
5-4F642EDMX	8	5/16	1/4 - 19	19	37.2	6.0	6.0	3.3
6F642EDMX	10	3/8	1/4 - 19	19	38.7	5.0	5.0	3.3
6-6F642EDMX	10	3/8	3/8 - 19	22	39.2	5.0	5.0	3.3
8F642EDMX	12	1/2	3/8 - 19	22	42.3	5.0	5.0	3.3
8-4F642EDMX	12	1/2	1/4 - 19	19	42.3	5.0	5.0	3.3
10F642EDMX	14, 15, 16	5/8	1/2 - 14	27	48.6	5.0	5.0	3.3
10-6F642EDMX	14, 15, 16	5/8	3/8 - 19	22	46.6	5.0	5.0	3.3
12F642EDMX	18, 20	3/4	3/4 - 14	32	51.7	5.0	5.0	3.3
12-8F642EDMX	18, 20	3/4	1/2 - 14	27	49.7	5.0	5.0	3.3
16F642EDMX	25	1	1 - 11	41	59.0	3.6	3.6	2.3
16-12F642EDMX	25	1	3/4 - 14	32	57.0	3.6	3.6	2.3
20F642EDMX	28, 30, 32	1 1/4	1 1/4 - 11	50	63.4	3.6	3.0	2.0
20-16F642EDMX	28, 30, 32	1 1/4	1 - 11	41	65.9	3.6	3.0	2.0
24F642EDMX	35, 38	1 1/2	1 1/2 - 11	55	74.1	2.5	2.0	1.3
24-20F642EDMX	35, 38	1 1/2	1 1/4 - 11	50	69.1	2.5	2.0	1.3

F63MX

Swivel – BSPT Connector
37° Swivel / BSPT

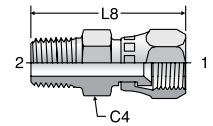

TUBE FITTING PART #	END SIZE			C4 (mm)	L8 (mm)	Dynamic Pressure (x 1,000 PSI)		
	1		2 BSPT			-S	-SS	-B
	(mm)	(in.)						
4F63MX	6	1/4	1/8 - 20	13	31.0	4.5	4.5	2.9
4-4F63MX	6	1/4	1/4 - 19	14	35.7	4.5	4.5	2.9
5-4F63MX	8	5/16	1/4 - 19	14	38.4	4.5	4.5	2.9
6F63MX	10	3/8	1/4 - 19	14	39.7	4.5	4.5	2.9
6-6F63MX	10	3/8	3/8 - 19	19	39.7	4.5	4.5	2.9
8-4F63MX	12	1/2	1/4 - 19	19	42.8	4.5	4.5	2.9
8F63MX	12	1/2	3/8 - 19	19	42.8	4.5	4.5	2.9
10F63MX	14, 15, 16	5/8	1/2 - 14	22	51.2	4.5	4.5	2.9
12-8F63MX	20	3/4	1/2 - 14	27	53.2	4.5	4.5	2.9
12F63MX	18, 20	3/4	3/4 - 14	27	53.2	2.3	2.3	1.5
16-12F63MX	25	1	3/4 - 14	32	55.7	2.3	2.3	1.5
16F63MX	25	1	1 - 11	36	62.5	2.3	2.3	1.5
20F63MX	30, 32	1 1/4	1 1/4 - 11	46	70.6	2.3	2.3	1.5

Dimensions and pressures for reference only, subject to change.

WNTX

45° Bulkhead Union Elbow
37° Flare / 37° Flare

SAE 070801
HPD Base # 3353
WNTX-WLN – Body with locknut
(See page B10 for WLN)

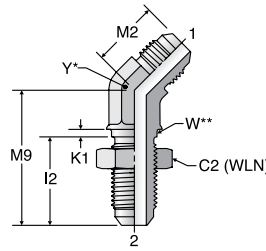

Y* – Across wrench flats.
W** – Bulkhead pilot dia.
recommended clearance hole
+.015 over W dia.

V6X

45° Swivel Nut Elbow
37° Flare / 37° Swivel

SAE 070321
HPD Base # 3703

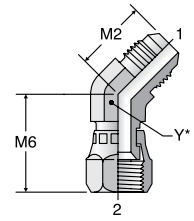

Y* – Across wrench flats

TUBE FITTING PART #	END SIZE		C2 HEX (in.)	I2 (in.)	K1 (in.)	M2 (in.)	M9 (in.)	W DIA (in.)	MAX BULKHEAD WALL THICKNESS (in.)	Y (in.)	Dynamic Pressure (x 1,000 PSI)		
	1 & 2 (in.)										-S	-SS	-B
4 WNTX	1/4	11/16	1.02	0.09	0.72	1.53	0.44	0.25	7/16	7.5	7.7	3.3	
5 WNTX	5/16	3/4	1.02	0.09	0.77	1.66	0.56	0.25	9/16	6.0	6.0	3.3	
6 WNTX	3/8	13/16	1.09	0.09	0.83	1.67	0.56	0.35	9/16	6.0	6.0	3.3	
8 WNTX	1/2	1	1.25	0.13	0.98	1.94	0.75	0.35	3/4	6.0	6.0	3.3	
10 WNTX	5/8	1 1/8	1.39	0.13	1.11	2.17	0.82	0.35	7/8	5.0	5.0	3.3	
12 WNTX	3/4	1 3/8	1.56	0.13	1.28	2.44	1.06	0.35	1 1/16	5.0	5.0	2.9	
16 WNTX	1	1 5/8	1.56	0.13	1.47	2.56	1.31	0.35	1 5/16	4.0	3.5	2.3	
20 WNTX	1 1/4	1 7/8	1.61	0.13	1.59	2.66	1.63	0.35	1 5/8	4.0	3.0	2.0	

TUBE FITTING PART #	END SIZE		M2 (in.)	M6 (in.)	Y (in.)	Dynamic Pressure (x 1,000 PSI)		
	1 & 2 (in.)					-S	-SS	-B
4 V6X	1/4		0.72	0.94	7/16	7.5	7.7	3.3
5 V6X	5/16		0.77	1.00	9/16	6.0	6.0	3.3
6 V6X	3/8		0.83	1.12	9/16	6.0	6.0	3.3
8 V6X	1/2		0.98	1.28	3/4	6.0	6.0	3.3
10 V6X	5/8		1.11	1.44	7/8	5.0	5.0	3.3
12 V6X	3/4		1.28	1.50	1 1/16	5.0	5.0	3.3
14 V6X	7/8		1.45	1.62	1 3/16	5.0	5.0	3.3
16 V6X	1		1.47	1.75	1 5/16	4.0	3.0	2.6
20 V6X	1 1/4		1.59	2.03	1 5/8	4.0	3.0	2.6
24 V6X	1 1/2		1.78	2.18	1 7/8	3.0	2.5	2.0
32 V6X	2		2.22	2.76	2 1/2	2.0	1.5	1.3

V50X

45° Straight Thread Elbow
37° Flare / SAE-ORB

SAE 070320
HPD Base # 3503

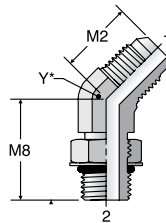

Y* – Across wrench flats

TUBE FITTING PART #	END SIZE		M2 (in.)	M8 (in.)	Y (in.)	Dynamic Pressure (x 1,000 PSI)			D
	1 (in.)	2 UN/UNF-2A				-S	-SS	-B	
4 V50X	1/4	7/16 - 20	0.72	1.05	7/16	6.0	6.0	3.3	3.0
4-6 V50X	1/4	9/16 - 18	0.82	1.14	9/16	6.0	5.4	3.3	3.0
5 V50X	5/16	1/2 - 20	0.77	1.05	9/16	6.0	5.4	3.3	3.0
6 V50X	3/8	9/16 - 18	0.83	1.14	9/16	6.0	5.4	3.3	3.0
6-4 V50X	3/8	7/16 - 20	0.83	1.08	9/16	6.0	5.4	3.3	3.0
6-8 V50X	3/8	3/4 - 16	0.86	1.30	3/4	6.0	5.4	3.3	3.0
8 V50X	1/2	3/4 - 16	0.98	1.30	3/4	6.0	5.4	3.3	3.0
8-6 V50X	1/2	9/16 - 18	0.98	1.09	3/4	6.0	5.4	3.3	3.0
8-10 V50X	1/2	7/8 - 14	1.00	1.52	7/8	5.0	5.4	3.3	2.5
8-12 V50X	1/2	1 1/16 - 12	1.04	1.73	1 1/16	5.0	5.4	3.3	2.5
10 V50X	5/8	7/8 - 14	1.11	1.52	7/8	5.0	5.4	3.3	2.5
10-8 V50X	5/8	3/4 - 16	1.11	1.38	7/8	5.0	5.4	3.3	2.5
10-12 V50X	5/8	1 1/16 - 12	1.16	1.73	1 1/16	5.0	5.4	3.3	2.5
12 V50X	3/4	1 1/16 - 12	1.28	1.73	1 1/16	5.0	5.4	3.3	2.5
12-10 V50X	3/4	7/8 - 14	1.28	1.58	1 1/16	5.0	5.4	3.3	2.5
12-16 V50X	3/4	1 5/16 - 12	1.42	1.86	1 5/16	4.0	3.0	2.6	2.0
14 V50X	7/8	1 3/16 - 12	1.45	1.86	1 5/16	5.0	5.4	3.3	2.5
16 V50X	1	1 5/16 - 12	1.47	1.86	1 5/16	4.0	3.0	2.6	2.0
16-12 V50X	1	1 1/16 - 12	1.47	1.86	1 5/16	4.0	3.0	2.6	2.0
16-20 V50X	1	1 5/8 - 12	1.55	1.91	1 5/8	4.0	2.5	2.0	•
20 V50X	1 1/4	1 5/8 - 12	1.59	1.91	1 5/8	4.0	2.5	2.0	•
20-16 V50X	1 1/4	1 5/16 - 12	1.59	1.91	1 5/8	4.0	2.5	2.0	•
24 V50X	1 1/2	1 7/8 - 12	1.78	1.91	1 7/8	3.0	2.0	1.5	•
32 V50X	2	2 1/2 - 12	2.22	1.86	2 1/2	2.0	1.5	1.3	•

V870MX

Male 45° Elbow – ISO 6149
37° Flare / ISO 6149

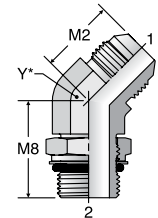

Y* – Across wrench flats

TUBE FITTING PART #	END SIZE		Male Metric Parallel Thread	M2 (mm)	M8 (mm)	Y (mm)	Dynamic Pressure (x 1,000 PSI)		
	1 (mm)	2 (in.)					-S	-SS	-B
4M12V870MX	6	1/4	M12X1.5	19.6	27.0	13	6.0	6.0	3.3
6M14V870MX	10	3/8	M14X1.5	21.1	28.0	14	6.0	6.0	3.3
8M16V870MX	12	1/2	M16 X 1.5	24.9	33.0	19	5.0	5.0	3.3
10M22V870MX	14, 15, 16	5/8	M22 X 1.5	28.2	37.5	22	5.0	5.0	3.3
12M27V870MX	18, 20	3/4	M27 X 2.0	32.5	46.0	27	5.0	5.0	3.3
16M33V870MX	25	1	M33 X 2.0	37.3	45.5	33	4.0	4.0	2.6

Dimensions and pressures for reference only, subject to change.



VTX

45° Male Elbow
37° Flare / NPTF

SAE 070302
HPD Base # 3103

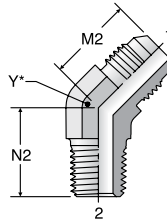

Y* – Across wrench flats

TUBE FITTING PART #	END SIZE		M2 (in.)	N2 (in.)	Y (in.)	Dynamic Pressure (x 1,000 PSI)		
	1 (in.)	2 NPTF				-S	-SS	-B
	2 VTX	1/8						
3 VTX	3/16	1/8 - 27	0.69	0.52	7/16	6.0	6.0	3.3
4 VTX	1/4	1/8 - 27	0.72	0.64	7/16	6.0	6.0	3.3
4-4 VTX	1/4	1/4 - 18	0.82	0.86	9/16	6.0	6.0	3.3
4-6 VTX	1/4	3/8 - 18	0.85	0.95	3/4	6.0	6.0	3.3
5 VTX	5/16	1/8 - 27	0.77	0.64	9/16	6.0	6.0	3.3
5-4 VTX	5/16	1/4 - 18	0.82	0.86	9/16	6.0	6.0	3.3
6 VTX	3/8	1/4 - 18	0.83	0.86	9/16	6.0	6.0	3.3
6-2 VTX	3/8	1/8 - 27	0.83	0.67	9/16	6.0	6.0	3.3
6-6 VTX	3/8	3/8 - 18	0.87	0.95	3/4	6.0	6.0	3.3
6-8 VTX	3/8	1/2 - 14	0.88	1.17	7/8	6.0	6.0	3.3
8 VTX	1/2	3/8 - 18	0.98	0.95	3/4	6.0	6.0	3.3
8-4 VTX	1/2	1/4 - 18	0.98	0.95	3/4	6.0	6.0	3.3
8-8 VTX	1/2	1/2 - 14	0.99	1.17	7/8	6.0	6.0	3.3
8-12 VTX	1/2	3/4 - 14	1.04	1.20	1 1/16	4.0	4.0	2.6
10 VTX	5/8	1/2 - 14	1.11	1.17	7/8	5.0	5.0	3.3
10-6 VTX	5/8	3/8 - 18	1.11	0.98	7/8	5.0	5.0	3.3
10-12 VTX	5/8	3/4 - 14	1.28	1.20	1 1/16	4.0	4.0	2.6
12 VTX	3/4	3/4 - 14	1.28	1.20	1 1/16	4.0	4.0	2.6
12-8 VTX	3/4	1/2 - 14	1.28	1.20	1 1/16	5.0	5.0	2.9
12-16 VTX	3/4	1 - 11 1/2	1.42	1.49	1 5/16	3.0	3.0	2.0
14 VTX	7/8	3/4 - 14	1.45	1.30	1 5/16	4.0	4.0	2.3
16 VTX	1	1 - 11 1/2	1.47	1.48	1 5/16	3.0	3.0	2.0
16-12 VTX	1	3/4 - 14	1.47	1.29	1 5/16	4.0	4.0	2.3
16-20 VTX	1	1 1/4 - 11 1/2	1.59	1.67	1 5/8	2.5	2.5	1.6
20 VTX	1 1/4	1 1/4 - 11 1/2	1.59	1.67	1 5/8	2.5	2.5	1.6
20-16 VTX	1 1/4	1 - 11 1/2	1.59	1.63	1 5/8	3.0	3.0	2.0
24 VTX	1 1/2	1 1/2 - 11 1/2	1.78	1.77	1 7/8	2.5	2.5	1.6
32 VTX	2	2 - 11 1/2	2.22	2.11	2 1/2	2.0	2.0	1.3

Note: All "VTX" fittings include a 30° chamfer for sealing with NPSM swivel type fittings (steel only).

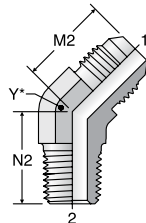

Y* – Across wrench flats

V3MX

Male 45° Elbow – BSPT
37° Flare / BSPT

TUBE FITTING PART #	END SIZE		M2 (mm)	N2 (mm)	Y (mm)	Dynamic Pressure (x 1,000 PSI)			
	1 (mm)	2 (in.) BSPT				-S	-SS	-B	
	4V3MX	6							1/4
4-4V3MX	6	1/4	1/4 - 19	20.8	21.8	14	4.5	4.5	2.9
6V3MX	10	3/8	1/4 - 19	21.1	21.8	14	4.5	4.5	2.9
6-6V3MX	10	3/8	3/8 - 19	22.1	24.1	19	4.5	4.5	2.9
8V3MX	12	1/2	3/8 - 19	24.9	24.1	19	4.5	4.5	2.9
8-8V3MX	12	1/2	1/2 - 14	25.2	29.7	22	4.5	4.5	2.9
12V3MX	18, 20	3/4	3/4 - 14	32.5	30.5	27	2.3	2.3	1.5

V40MX

Male 45° Elbow – BSPP
37° Flare / BSPP-ORR

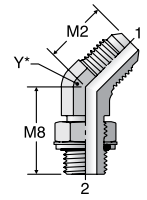

Y* – Across wrench flats

TUBE FITTING PART #	END SIZE		M2 (mm)	M8 (mm)	Y (mm)	Dynamic Pressure (x 1,000 PSI)			
	1 (mm)	2 (in.) BSPP				-S	-SS	-B	
	4V40MX	6							1/4
6V40MX	10	3/8	1/4 - 19	21.1	29.0	14	3.6	3.6	2.3
8V40MX	12	1/2	3/8 - 19	24.9	33.0	19	3.6	3.6	2.3
10V40MX	14,15,16	5/8	1/2 - 14	28.2	38.5	22	3.6	3.6	2.3
12V40MX	18,20	3/4	3/4 - 14	32.5	44.0	27	3.6	3.6	2.3
16V40MX	25	1	1 - 11	37.3	47.0	33	3.6	3.6	2.3

ETX

Union Elbow
37° Flare / 37° Flare

SAE 070201
HPD Base # 2303

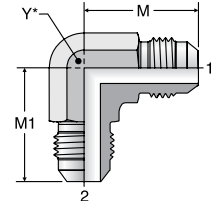

Y* – Across wrench flats

TUBE FITTING PART #	END SIZE		M (in.)	M1 (in.)	Y (in.)	Dynamic Pressure (x 1,000 PSI)		
	1 (in.)	2 (in.)				-S	-SS	-B
	2 ETX	1/8						
3 ETX	3/16	3/16	0.83	0.83	7/16	7.5	7.7	3.3
4 ETX	1/4	1/4	0.89	0.89	7/16	7.5	7.7	3.3
5 ETX	5/16	5/16	0.97	0.97	9/16	6.0	6.0	3.3
6 ETX	3/8	3/8	1.06	1.06	9/16	6.0	6.0	3.3
6-4 ETX	3/8	1/4	1.06	1.05	9/16	6.0	6.0	3.3
8 ETX	1/2	1/2	1.25	1.25	3/4	6.0	6.0	3.3
8-6 ETX	1/2	3/8	1.25	1.14	3/4	6.0	6.0	3.3
10 ETX	5/8	5/8	1.45	1.45	7/8	5.0	5.0	3.3
10-8 ETX	5/8	1/2	1.45	1.33	7/8	5.0	5.0	3.3
12 ETX	3/4	3/4	1.66	1.66	1 1/16	5.0	5.0	3.3
12-8 ETX	3/4	1/2	1.66	1.42	1 1/16	5.0	5.0	3.3
12-10 ETX	3/4	5/8	1.66	1.54	1 1/16	5.0	5.0	3.3
14 ETX	7/8	7/8	1.80	1.80	1 3/16	5.0	5.0	3.3
16 ETX	1	1	1.81	1.81	1 5/16	4.0	3.5	2.3
16-12 ETX	1	3/4	1.81	1.77	1 5/16	4.0	3.5	2.3
20 ETX	1 1/4	1 1/4	2.06	2.06	1 5/8	4.0	3.0	2.0
24 ETX	1 1/2	1 1/2	2.33	2.33	1 7/8	3.0	2.0	1.3
32 ETX	2	2	3.06	3.06	2 1/2	2.0	1.5	1.0

Dimensions and pressures for reference only, subject to change.



WETX

Bulkhead Union Elbow
37° Flare / 37° Flare

SAE 070701
HPD Base # 2353
WETX-WLN – Body with locknut
(See page B10 for WLN)

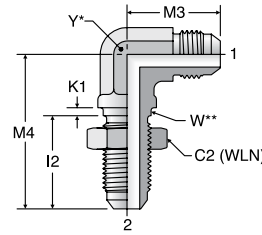

Y* – Across wrench flats.
W** – Bulkhead pilot dia.
recommended clearance hole
+.015 over W dia.

TUBE FITTING PART #	END SIZE		C2 HEX (in.)	I2 (in.)	K1 (in.)	M3 (in.)	M4 (in.)	W DIA (in.)	MAX BULKHEAD WALL THICKNESS (in.)	Y (in.)	Dynamic Pressure (x 1,000 PSI)		
	1 & 2 (in.)										-S	-SS	-B
3 WETX	3/16		5/8	0.92	0.09	0.94	1.50	0.38	0.25	7/16	7.5	7.7	3.3
4 WETX	1/4		11/16	1.20	0.09	0.97	1.59	0.44	0.25	7/16	7.5	7.7	3.3
5 WETX	5/16		3/4	1.02	0.09	1.06	1.72	0.50	0.25	9/16	6.0	6.0	3.3
6 WETX	3/8		13/16	1.09	0.09	1.09	1.81	0.56	0.35	9/16	6.0	6.0	3.3
8 WETX	1/2		1	1.25	0.13	1.36	2.11	0.75	0.35	3/4	6.0	6.0	3.3
10 WETX	5/8		1 1/8	1.39	0.13	1.56	2.39	0.88	0.35	7/8	5.0	5.0	3.3
12 WETX	3/4		1 3/8	1.56	0.13	1.78	2.67	1.06	0.35	1 1/16	5.0	5.0	3.3
14 WETX	7/8		1 1/2	1.56	0.13	1.92	2.80	1.19	0.35	1 5/8	5.0	5.0	3.3
16 WETX	1		1 5/8	1.56	0.13	1.94	2.80	1.31	0.35	1 5/8	4.0	3.5	2.3
20 WETX	1 1/4		1 7/8	1.61	0.13	2.17	3.13	1.63	0.35	1 5/8	4.0	3.0	2.0

C6X

Swivel Nut Elbow
37° Flare / 37° Swivel

SAE 070221
HPD Base # 3903

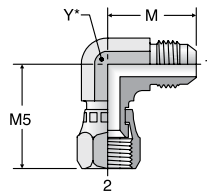

Y* – Across wrench flats

TUBE FITTING PART #	END SIZE		M (in.)	M5 (in.)	Y (in.)	Dynamic Pressure (x 1,000 PSI)			
	1 (in.)	2 (in.)				-S	-SS	-B	D
3 C6X	3/16	3/16	0.83	1.00	7/16	7.5	7.7	3.3	3.8
4 C6X	1/4	1/4	0.89	1.00	7/16	7.5	7.7	3.3	3.8
5 C6X	5/16	5/16	0.95	1.06	9/16	6.0	6.0	3.3	3.0
6 C6X	3/8	3/8	1.06	1.25	9/16	6.0	6.0	3.3	3.0
8 C6X	1/2	1/2	1.25	1.38	3/4	6.0	6.0	3.3	3.0
10 C6X	5/8	5/8	1.45	1.62	7/8	5.0	5.0	3.3	2.5
12 C6X	3/4	3/4	1.66	1.75	1 1/16	5.0	5.0	3.3	2.5
12-24 C6X	3/4	1 1/2	2.11	2.59	1 7/8	3.0	2.5	2.0	•
14 C6X	7/8	7/8	1.81	1.78	1 5/16	5.0	5.0	3.3	2.5
16 C6X	1	1	1.81	2.00	1 5/16	4.0	3.0	2.6	2.0
16-12 C6X	1	3/4	1.81	1.87	1 5/16	4.0	3.0	2.6	2.0
20 C6X	1 1/4	1 1/4	2.06	2.31	1 5/8	4.0	3.0	2.6	•
24 C6X	1 1/2	1 1/2	2.33	2.59	1 7/8	3.0	2.5	2.0	•
32 C6X	2	2	3.06	3.51	2 1/2	2.0	1.5	1.3	•

AOEX6

Swivel Elbow Straight
Thread Connector
SAE-ORB / 37° Swivel

HPD Base # 2506

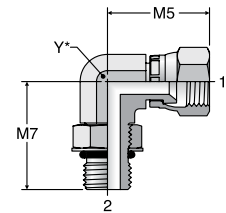

Y* – Across wrench flats

TUBE FITTING PART #	END SIZE		M5 (in.)	M7 (in.)	Y (in.)	Dynamic Pressure (x 1,000 PSI)		
	1 (in.)	2 UN/UNF-2A				-S	-SS	-B
4 AOEX6	1/4	7/16 - 20	1.00	1.03	7/16	6.0	6.0	3.3
6 AOEX6	3/8	9/16 - 18	1.25	1.25	9/16	6.0	6.0	3.3
8 AOEX6	1/2	3/4 - 16	1.38	1.45	3/4	6.0	6.0	3.3
10 AOEX6	5/8	7/8 - 14	1.62	1.70	7/8	5.0	5.0	3.3
12 AOEX6	3/4	1 1/16 - 12	1.75	1.94	1 1/16	5.0	5.0	3.3
16 AOEX6	1	1 5/16 - 12	2.00	2.05	1 5/16	4.0	3.0	2.6

Dimensions and pressures for reference only, subject to change.

X6EF

Swivel Elbow Connector
37° Swivel / NPTF

HPD Base # 2106

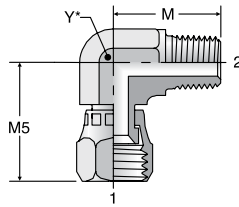

Y* – Across wrench flats

TUBE FITTING PART #	END SIZE		M (in.)	M5 (in.)	Y (in.)	Dynamic Pressure (x 1,000 PSI)		
	1 (in.)	2 NPTF				-S	-SS	-B
4 X6EF	1/4	1/8 - 27	0.78	1.01	7/16	6.0	6.0	3.3
4-4 X6EF	1/4	1/4 - 18	1.09	1.13	9/16	6.0	6.0	3.3
6 X6EF	3/8	1/4 - 18	1.09	1.25	9/16	6.0	6.0	3.3
6-6 X6EF	3/8	3/8 - 18	1.22	1.27	3/4	6.0	6.0	3.3
8 X6EF	1/2	3/8 - 18	1.22	1.38	3/4	6.0	6.0	3.3
8-8 X6EF	1/2	1/2 - 14	1.47	1.48	7/8	6.0	6.0	3.3
10 X6EF	5/8	1/2 - 14	1.47	1.62	7/8	5.0	5.0	3.3
12 X6EF	3/4	3/4 - 14	1.59	1.75	1 1/16	4.0	4.0	2.6
16 X6EF	1	1 - 11	1.97	2.01	1 5/16	3.0	3.0	2.0

CC50X

Long Straight Thread Elbow
37° Flare / SAE-ORB

SAE 071520
HPD Base # 5503

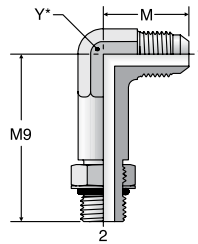

Y* – Across wrench flats

TUBE FITTING PART #	END SIZE		M (in.)	M9 (in.)	Y (in.)	Dynamic Pressure (x 1,000 PSI)		
	1 (in.)	2 UN/UNF-2A				-S	-SS	-B
4 CC50X	1/4	7/16 - 20	0.89	1.73	9/16	6.0	6.0	3.3
6 CC50X	3/8	9/16 - 18	1.06	2.08	9/16	6.0	5.4	3.3
8 CC50X	1/2	3/4 - 16	1.25	2.50	7/8	6.0	5.4	3.3
10 CC50X	5/8	7/8 - 14	1.45	2.89	7/8	5.0	5.4	3.3
12 CC50X	3/4	1 1/16 - 12	1.66	3.34	1 1/16	5.0	5.4	3.3
16 CC50X	1	1 5/16 - 12	1.81	3.72	1 5/16	4.0	3.0	2.6

C50X

Straight Thread Elbow
37° Flare / SAE-ORB

SAE 070220
HPD Base # 2503

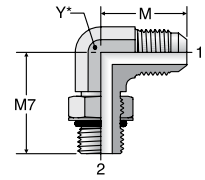

Y* – Across wrench flats

TUBE FITTING PART #	END SIZE		M (in.)	M7 (in.)	Y (in.)	Dynamic Pressure (x 1,000 PSI)			
	1 (in.)	2 UN/UNF-2A				-S	-SS	-B	D
2 C50X	1/8	5/16 - 24	0.77	0.94	7/16	5.0	6.0	3.3	3.0
3 C50X	3/16	3/8 - 24	0.83	0.94	7/16	5.0	6.0	3.3	3.0
4 C50X	1/4	7/16 - 20	0.89	1.03	7/16	6.0	6.0	3.3	3.0
4-2 C50X	1/4	5/16 - 24	0.89	0.92	7/16	5.0	6.0	3.3	3.0
4-6 C50X	1/4	9/16 - 18	1.05	1.25	9/16	6.0	5.4	3.3	3.0
4-8 C50X	1/4	3/4 - 16	1.13	1.45	3/4	6.0	5.4	3.3	3.0
5 C50X	5/16	1/2 - 20	0.95	1.13	9/16	6.0	5.4	3.3	3.0
5-4 C50X	5/16	7/16 - 18	0.95	1.13	9/16	6.0	5.4	3.3	3.0
5-6 C50X	5/16	9/16 - 18	1.06	1.25	9/16	6.0	5.4	3.3	3.0
6 C50X	3/8	9/16 - 18	1.06	1.25	9/16	6.0	5.4	3.3	3.0
6-4 C50X	3/8	7/16 - 20	1.06	1.19	9/16	6.0	5.4	3.3	3.0
6-5 C50X	3/8	1/2 - 20	1.06	1.19	9/16	6.0	5.4	3.3	3.0
6-8 C50X	3/8	3/4 - 16	1.14	1.45	3/4	6.0	5.4	3.3	3.0
6-10 C50X	3/8	7/8 - 14	1.23	1.70	7/8	6.0	5.4	3.3	3.0
8 C50X	1/2	3/4 - 16	1.25	1.45	3/4	6.0	5.4	3.3	3.0
8-4 C50X	1/2	7/16 - 20	1.25	1.26	3/4	6.0	5.4	3.3	3.0
8-6 C50X	1/2	9/16 - 18	1.25	1.34	3/4	6.0	5.4	3.3	3.0
8-10 C50X	1/2	7/8 - 14	1.33	1.70	7/8	5.0	5.4	3.3	3.0
8-12 C50X	1/2	1 1/16 - 12	1.42	1.94	1 1/16	5.0	5.4	3.3	3.0
8-16 C50X	1/2	1 5/16 - 12	1.52	2.05	1 5/16	4.0	3.0	2.6	3.0
10 C50X	5/8	7/8 - 14	1.45	1.70	7/8	5.0	5.4	3.3	2.5
10-6 C50X	5/8	9/16 - 18	1.45	1.41	7/8	5.0	5.4	3.3	2.5
10-8 C50X	5/8	3/4 - 16	1.45	1.55	7/8	5.0	5.4	3.3	2.5
10-12 C50X	5/8	1 1/16 - 12	1.53	1.94	1 1/16	5.0	5.4	3.3	2.5
10-16 C50X	5/8	1 5/16 - 12	1.64	2.05	1 5/16	4.0	3.0	2.6	2.5
12 C50X	3/4	1 1/16 - 12	1.66	1.94	1 1/16	5.0	5.4	3.3	2.5
12-8 C50X	3/4	3/4 - 16	1.66	1.63	1 1/16	5.0	5.4	3.3	2.5
12-10 C50X	3/4	7/8 - 14	1.66	1.78	1 1/16	5.0	5.4	3.3	2.5
12-14 C50X	3/4	1 3/16 - 12	1.77	2.00	1 5/16	5.0	5.4	3.3	2.5
12-16 C50X	3/4	1 5/16 - 12	1.76	2.05	1 5/16	4.0	3.0	2.6	2.5
12-20 C50X	3/4	1 5/8 - 12	1.97	2.25	1 5/8	4.0	3.0	2.6	2.5
14 C50X	7/8	1 3/16 - 12	1.80	2.05	1 5/16	5.0	5.4	3.3	2.5
16 C50X	1	1 5/16 - 12	1.81	2.05	1 5/16	4.0	3.0	2.6	2.0
16-12 C50X	1	1 1/16 - 12	1.81	2.05	1 5/16	4.0	3.0	2.6	2.0
16-14 C50X	1	1 3/16 - 12	1.81	2.05	1 5/16	4.0	3.0	2.6	2.0
16-20 C50X	1	1 5/8 - 12	2.01	2.25	1 5/8	4.0	2.5	2.0	•
16-24 C50X	1	1 7/8 - 12	2.16	2.39	1 7/8	3.0	2.5	2.0	•
20 C50X	1 1/4	1 5/8 - 12	2.06	2.25	1 5/8	4.0	2.5	2.0	•
20-16 C50X	1 1/4	1 5/16 - 12	2.06	2.25	1 5/8	4.0	2.5	2.0	•
20-24 C50X	1 1/4	1 7/8 - 12	2.20	2.39	1 7/8	3.0	2.5	2.0	•
24 C50X	1 1/2	1 7/8 - 12	2.33	2.39	1 7/8	3.0	2.0	1.5	•
24-20 C50X	1 1/2	1 5/8 - 12	2.33	2.39	1 7/8	3.0	2.0	1.5	•
32 C50X	2	2 1/2 - 12	3.06	2.89	2 1/2	2.0	1.5	1.3	•
32-24 C50X	2	1 7/8 - 12	3.06	2.89	2 1/2	2.0	1.5	1.3	•

Dimensions and pressures for reference only, subject to change.

CTX

Male Elbow
37° Flare / NPTF

SAE 070202
HPD Base # 2103

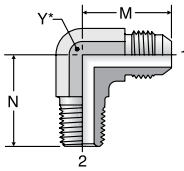

Y* – Across wrench flats

CCTX

Long Male Elbow
37° Flare / NPTF

SAE 071502
HPD Base # 5603

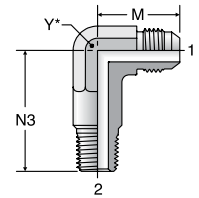

Y* – Across wrench flats

TUBE FITTING PART #	END SIZE		M (in.)	N (in.)	Y (in.)	Dynamic Pressure (x 1,000 PSI)			
	1 (in.)	2 NPTF				-S	-SS	-B	D
2 CTX	1/8	1/8 - 27	0.77	0.72	5/16	6.0	6.0	3.3	3.0
3 CTX	3/16	1/8 - 27	0.83	0.72	3/8	6.0	6.0	3.3	3.0
4 CTX	1/4	1/8 - 27	0.89	0.78	7/16	6.0	6.0	3.3	3.0
4-4 CTX	1/4	1/4 - 18	1.05	1.09	9/16	6.0	6.0	3.3	3.0
4-6 CTX	1/4	3/8 - 18	1.12	1.22	3/4	6.0	6.0	3.3	3.0
4-8 CTX	1/4	1/2 - 14	1.21	1.47	7/8	6.0	6.0	3.3	3.0
5 CTX	5/16	1/8 - 27	0.95	0.78	9/16	6.0	6.0	3.3	3.0
5-4 CTX	5/16	1/4 - 18	1.05	1.09	9/16	6.0	6.0	3.3	3.0
5-6 CTX	5/16	3/8 - 18	1.12	1.22	3/4	6.0	6.0	3.3	3.0
6 CTX	3/8	1/4 - 18	1.06	1.09	9/16	6.0	6.0	3.3	3.0
6-2 CTX	3/8	1/8 - 27	1.06	0.90	9/16	6.0	6.0	3.3	3.0
6-6 CTX	3/8	3/8 - 18	1.14	1.22	3/4	6.0	6.0	3.3	3.0
6-8 CTX	3/8	1/2 - 14	1.22	1.47	7/8	6.0	6.0	3.3	3.0
6-12 CTX	3/8	3/4 - 14	1.31	1.59	1 1/16	4.0	4.0	2.6	2.0
8 CTX	1/2	3/8 - 18	1.25	1.22	3/4	6.0	6.0	3.3	3.0
8-4 CTX	1/2	1/4 - 18	1.25	1.22	3/4	6.0	6.0	3.3	3.0
8-8 CTX	1/2	1/2 - 14	1.33	1.47	7/8	6.0	6.0	3.3	3.0
8-12 CTX	1/2	3/4 - 14	1.42	1.59	1 1/16	4.0	4.0	2.6	2.0
8-16 CTX	1/2	1 - 11 1/2	1.52	1.97	1 5/16	3.0	3.0	2.0	1.5
10 CTX	5/8	1/2 - 14	1.45	1.47	7/8	5.0	5.0	3.3	2.5
10-6 CTX	5/8	3/8 - 18	1.45	1.28	7/8	5.0	5.0	3.3	2.5
10-12 CTX	5/8	3/4 - 14	1.53	1.59	1 1/16	4.0	4.0	2.6	2.0
10-16 CTX	5/8	1 - 11 1/2	1.64	1.97	1 5/16	3.0	3.0	2.0	1.5
12 CTX	3/4	3/4 - 14	1.66	1.59	1 1/16	4.0	4.0	2.6	2.0
12-6 CTX	3/4	3/8 - 18	1.66	1.40	1 1/16	5.0	5.0	3.3	2.0
12-8 CTX	3/4	1/2 - 14	1.66	1.59	1 1/16	5.0	5.0	2.9	2.0
12-16 CTX	3/4	1 - 11 1/2	1.76	1.97	1 5/16	3.0	3.0	2.0	1.5
14 CTX	7/8	3/4 - 14	1.80	1.69	1 5/16	4.0	4.0	2.3	2.0
16 CTX	1	1 - 11 1/2	1.81	1.97	1 5/16	3.0	3.0	2.0	1.5
16-8 CTX	1	1/2 - 14	1.81	1.66	1 5/16	4.0	4.0	2.3	1.5
16-12 CTX	1	3/4 - 14	1.81	1.78	1 5/16	4.0	4.0	2.3	1.5
16-20 CTX	1	1 1/4 - 11 1/2	2.01	2.38	1 5/8	2.5	2.5	1.6	•
20 CTX	1 1/4	1 1/4 - 11 1/2	2.06	2.38	1 5/8	2.5	2.5	1.6	•
20-16 CTX	1 1/4	1 - 11 1/2	2.06	2.06	1 5/8	3.0	3.0	2.0	•
20-24 CTX	1 1/4	1 1/2 - 11 1/2	2.21	2.64	1 7/8	2.5	2.5	1.6	•
24 CTX	1 1/2	1 1/2 - 11 1/2	2.33	2.64	1 7/8	2.5	2.5	1.6	•
24-20 CTX	1 1/2	1 1/4 - 11 1/2	2.33	2.25	1 7/8	2.5	2.5	1.6	•
24-32 CTX	1 1/2	2 - 11 1/2	2.81	3.00	2 1/2	2.0	2.0	1.3	•
32 CTX	2	2 - 11 1/2	3.06	3.00	2 1/2	2.0	2.0	1.3	•
32-24 CTX	2	1 1/2 - 11 1/2	3.06	2.97	2 1/2	2.0	2.0	1.3	•
40 CTX	2 1/2	2 1/2 - 8	2.86	3.57	3 1/4	1.0	1.0	0.6	•

Note: All steel "CTX" fittings have a 30° chamfer for sealing with NPSM swivel type fittings.

TUBE FITTING PART #	END SIZE		M (in.)	N3 (in.)	Y (in.)	Dynamic Pressure (x 1,000 PSI)		
	1 (in.)	2 NPTF				-S	-SS	-B
4 CCTX	1/4	1/8 - 27	0.89	1.17	7/16	6.0	6.0	3.3
4-4 CCTX	1/4	1/4 - 18	1.05	1.58	9/16	6.0	6.0	3.3
5 CCTX	5/16	1/8 - 27	0.95	1.17	9/16	6.0	6.0	3.3
6 CCTX	3/8	1/4 - 18	1.06	1.58	9/16	6.0	6.0	3.3
6-6 CCTX	3/8	3/8 - 18	1.14	1.82	3/4	6.0	6.0	3.3
8 CCTX	1/2	3/8 - 18	1.25	1.82	3/4	6.0	6.0	3.3
8-8 CCTX	1/2	1/2 - 14	1.33	2.17	7/8	6.0	6.0	3.3
8-12 CCTX	1/2	3/4 - 14	1.42	2.44	1 1/16	4.0	4.0	2.6
10 CCTX	5/8	1/2 - 14	1.45	2.17	7/8	5.0	5.0	3.3
12 CCTX	3/4	3/4 - 14	1.66	2.44	1 1/16	4.0	4.0	2.6
14 CCTX	7/8	3/4 - 14	1.80	2.59	1 5/16	4.0	4.0	2.3
16 CCTX	1	1 - 11 1/2	1.81	3.01	1 5/16	3.0	3.0	2.0
20 CCTX	1 1/4	1 1/4 - 11 1/2	2.06	3.69	1 5/8	2.5	2.5	1.6

Note: All steel "CCTX" fittings have a 30° chamfer for sealing with NPSM swivel type fittings.

CCCTX

Extra Long Male Elbow
37° Flare / NPTF

SAE 071602
HPD Base # 5703

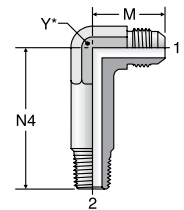

Y* – Across wrench flats

TUBE FITTING PART #	END SIZE		M (in.)	N4 (in.)	Y (in.)	Dynamic Pressure (x 1,000 PSI)		
	1 (in.)	2 NPTF				-S	-SS	-B
4 CCCTX	1/4	1/8 - 27	0.89	1.56	7/16	6.0	6.0	3.3
4-4 CCCTX	1/4	1/4 - 18	1.05	2.07	9/16	6.0	6.0	3.3
5 CCCTX	5/16	1/8 - 27	0.97	1.63	9/16	6.0	6.0	3.3
6 CCCTX	3/8	1/4 - 18	1.06	2.07	9/16	6.0	6.0	3.3
6-6 CCCTX	3/8	3/8 - 18	1.14	2.34	3/4	6.0	6.0	3.3
8 CCCTX	1/2	3/8 - 18	1.25	2.34	3/4	6.0	6.0	3.3
8-8 CCCTX	1/2	1/2 - 14	1.33	2.87	7/8	6.0	6.0	3.3
10 CCCTX	5/8	1/2 - 14	1.45	2.87	7/8	5.0	5.0	3.3
12 CCCTX	3/4	3/4 - 14	1.66	3.28	1 1/16	4.0	4.0	2.3
16 CCCTX	1	1 - 11 1/2	1.81	4.05	1 5/16	3.0	3.0	2.0
20 CCCTX	1 1/4	1 1/4 - 11 1/2	2.06	5.00	1 5/8	2.5	2.5	1.6

Note: All steel "CCCTX" fittings have a 30° chamfer for sealing with NPSM swivel type fittings.

Dimensions and pressures for reference only, subject to change.

DTX

Femle Elbow
37° Flare / NPTF

SAE 070203
HPD Base # 2203

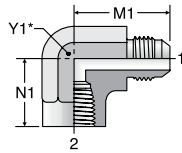

Y* – Across wrench flats

C870MX

Male Elbow – ISO 6149
37° Flare / ISO 6149

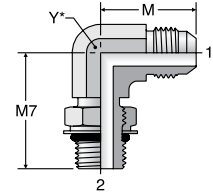

Y* – Across wrench flats

TUBE FITTING PART #	END SIZE		M1 (in.)	N1 (in.)	Y1 (in.)	Dynamic Pressure (x 1,000 PSI)		
	1 (in.)	2 NPTF				-S	-SS	-B
4 DTX	1/4	1/8 - 27	1.08	0.66	9/16	5.0	5.0	3.3
4-4 DTX	1/4	1/4 - 18	1.22	0.88	3/4	5.0	5.0	3.3
5 DTX	5/16	1/8 - 27	1.08	0.66	9/16	5.0	5.0	3.3
5-4 DTX	5/16	1/4 - 18	1.22	0.88	3/4	5.0	5.0	3.3
6 DTX	3/8	1/4 - 18	1.23	0.88	3/4	5.0	5.0	3.3
6-2 DTX	3/8	1/8 - 27	1.23	0.67	9/16	5.0	5.0	3.3
6-6 DTX	3/8	3/8 - 18	1.31	1.02	7/8	4.5	4.5	2.9
8 DTX	1/2	3/8 - 18	1.42	1.02	7/8	4.5	4.5	2.9
8-4 DTX	1/2	1/4 - 18	1.42	1.01	3/4	4.5	4.5	2.9
8-8 DTX	1/2	1/2 - 14	1.52	1.23	1 1/16	3.0	3.0	2.0
10 DTX	5/8	1/2 - 14	1.64	1.23	1 1/16	3.0	3.0	2.0
12 DTX	3/4	3/4 - 14	1.89	1.36	1 5/16	3.0	3.0	2.0
12-8 DTX	3/4	1/2 - 14	1.89	1.35	1 1/16	3.0	3.0	2.0
14 DTX	7/8	3/4 - 14	1.86	1.42	1 5/16	3.0	3.0	2.0
16 DTX	1	1 - 11 1/2	2.17	1.62	1 5/8	1.8	1.8	1.2
20 DTX	1 1/4	1 1/4 - 11 1/2	2.33	1.70	1 7/8	1.5	1.5	1.0
24 DTX	1 1/2	1 1/2 - 11 1/2	2.89	2.08	2 1/2	1.5	1.5	1.0

TUBE FITTING PART #	END SIZE		Male Metric Parallel Thread	M (mm)	M7 (mm)	Y (mm)	Dynamic Pressure (x 1,000 PSI)		
	1 (mm)	2 (in.)					-S	-SS	-B
4M10C870MX	6	1/4	M10x1	22.6	27.1	11	6.0	5.0	3.3
5M12C870MX	8	5/16	M12x1.5	24.1	30.5	13	6.0	5.0	3.3
6M14C870MX	10	3/8	M14x1.5	26.9	33.5	14	6.0	5.0	3.3
8M16C870MX	12	1/2	M16x1.5	31.8	38.0	19	5.0	5.0	3.3
8M18C870MX	12	1/2	M18x1.5	31.8	38.0	19	5.0	5.0	3.3
10M18C870MX	14, 15, 16	5/8	M18x1.5	36.8	41.5	22	5.0	5.0	3.3
10M22C870MX	14, 15, 16	5/8	M22x1.5	36.8	42.5	22	5.0	5.0	3.3
12M22C870MX	18, 20	3/4	M22x.15	42.2	45.0	27	5.0	5.0	3.3
12M27C870MX	18, 20	3/4	M27x2	42.2	51.0	27	5.0	5.0	3.3
16M33C870MX	25	1	M33x2	46.0	53.0	33	4.0	4.0	2.6

C80MX

Male Elbow – Metric-ORR
37° Flare / Metric-ORR

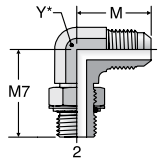

Y* – Across wrench flats

TUBE FITTING PART #	END SIZE		Male Metric Parallel Thread	M (mm)	M7 (mm)	Y (mm)	Dynamic Pressure (x 1,000 PSI)		
	1 (mm)	2 (in.)					-S	-SS	-B
4M10C80MX	6	1/4	M10x1	22.6	27.1	11	3.6	3.6	2.3
5M12C80MX	8	5/16	M12x1.5	24.1	30.5	13	3.6	3.6	2.3
6M14C80MX	10	3/8	M14x1.5	26.9	33.5	14	3.6	3.6	2.3
8M16C80MX	12	1/2	M16x1.5	31.8	38.0	19	3.6	3.6	2.3
8M18C80MX	12	1/2	M18x1.5	31.8	38.0	19	3.6	3.6	2.3
10M18C80MX	14, 15, 16	5/8	M18x1.5	36.8	41.5	22	3.6	3.6	2.3
10M22C80MX	14, 15, 16	5/8	M22x1.5	36.8	42.5	22	3.6	3.6	2.3
12M22C80MX	18, 20	3/4	M22x.15	42.2	45.0	27	3.6	3.6	2.3
12M27C80MX	18, 20	3/4	M27x2.0	42.2	51.0	27	2.5	2.5	1.6
16M33C80MX	25	1	M33x2.0	46.0	53.0	33	2.0	2.0	1.3

Dimensions and pressures for reference only, subject to change.



C40MX

Male Elbow – BSPP
37° Flare / BSPP-ORR

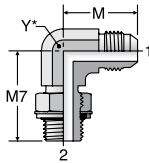

Y* – Across wrench flats

C3MX

Male Elbow – BSPT
37° Flare / BSPT

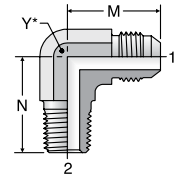

Y* – Across wrench flats

TUBE FITTING PART #	END SIZE			M (mm)	M7 (mm)	Y (mm)	Dynamic Pressure (x 1,000 PSI)		
	1		2				-S	-SS	-B
	(mm)	(in.)	BSPP						
4C40MX	6	1/4	1/8-28	22.6	26.5	11	3.6	3.6	2.3
4-4C40MX	6	1/4	1/4-19	26.9	32.0	14	3.6	2.9	1.9
5C40MX	8	5/16	1/8-28	24.1	27.0	13	3.6	3.6	2.3
5-4C40MX	8	5/16	1/4-19	26.6	32.0	14	3.6	2.9	1.9
5-6C40MX	8	5/16	3/8-19	28.5	37.0	19	3.6	2.9	1.9
6C40MX	10	3/8	1/4-19	26.9	32.0	14	3.6	2.9	1.9
6-6C40MX	10	3/8	3/8-19	29.0	37.0	19	3.6	2.9	1.9
8-4C40MX	12	1/2	1/4-19	31.8	37.0	19	3.6	2.9	1.9
8C40MX	12	1/2	3/8-19	31.8	37.0	19	3.6	2.9	1.9
8-8C40MX	12	1/2	1/2-14	33.8	43.0	22	3.6	2.9	1.9
10-6C40MX	16	5/8	3/8-19	36.8	36.0	22	3.6	2.9	1.9
10C40MX	14,15,16	5/8	1/2-14	36.8	43.0	22	3.6	2.9	1.9
10-12C40MX	15	5/8	3/4-14	39.2	49.5	27	3.6	2.9	1.9
12-8C40MX	18,20	3/4	1/2-14	42.2	49.5	27	3.6	2.9	1.9
12C40MX	18,20	3/4	3/4-14	42.2	49.5	27	3.6	2.9	1.9
12-16C40MX	18	3/4	1-11	44.7	52.0	33	3.6	2.9	1.9
16-12C40MX	25	1	3/4-14	46.0	47.0	33	3.6	2.9	1.9
16C40MX	25	1	1-11	46.0	52.0	33	3.6	2.9	1.9
20-16C40MX	30,32	1 1/4	1-11	52.3	57.0	41	3.6	2.3	1.5
20C40MX	30,32	1 1/4	1 1/4-11	52.3	57.0	41	3.0	2.3	1.5
24-20C40MX	38	1 1/2	1 1/4-11	59.2	60.5	48	3.0	2.0	1.3
24C40MX	38	1 1/2	1 1/2-11	59.2	60.5	48	2.0	2.0	1.3

TUBE FITTING PART #	END SIZE			M (mm)	N (mm)	Y (mm)	Dynamic Pressure (x 1,000 PSI)		
	1		2				-S	-SS	-B
	(mm)	(in.)	BSPT						
4C3MX	6	1/4	1/8 - 28	22.6	19.8	11	4.5	4.5	2.9
4-4C3MX	6	1/4	1/4 - 19	26.6	27.7	14	4.5	4.5	2.9
5C3MX	8	5/16	1/8 - 28	24.1	19.8	13	4.5	4.5	2.9
5-4C3MX	8	5/16	1/4 - 19	26.6	27.7	14	4.5	4.5	2.9
6C3MX	10	3/8	1/4 - 19	26.9	27.7	14	4.5	4.5	2.9
6-6C3MX	10	3/8	3/8 - 19	29.0	31.0	19	4.5	4.5	2.9
6-8C3MX	10	3/8	1/2 - 14	31.0	37.3	22	4.5	4.5	2.9
8-4C3MX	12	1/2	1/4 - 19	31.8	31.0	19	4.5	4.5	2.9
8C3MX	12	1/2	3/8 - 19	31.8	31.0	19	4.5	4.5	2.9
8-8C3MX	12	1/2	1/2 - 14	33.8	37.3	22	4.5	4.5	2.9
10-6C3MX	14,15,16	5/8	3/8 - 19	36.8	32.5	22	4.5	4.5	2.9
10C3MX	14,15,16	5/8	1/2 - 14	36.8	37.3	22	4.5	4.5	2.9
10-12C3MX	14,15,16	5/8	3/4 - 14	39.2	40.4	27	2.3	2.3	1.5
12-8C3MX	18,20	3/4	1/2 - 14	42.2	40.4	27	4.5	4.5	2.9
12C3MX	18,20	3/4	3/4 - 14	42.2	40.4	27	2.3	2.3	1.5
16-12C3MX	25	1	3/4 - 14	46.0	45.2	33	2.3	2.3	1.5
16C3MX	25	1	1 - 11	46.0	50.0	33	2.3	2.3	1.5
20-16C3MX	30,32	1 1/4	1 - 11	52.3	59.7	41	2.3	2.3	1.5
20C3MX	30,32	1 1/4	1 1/4 - 11	52.3	60.5	41	2.3	2.3	1.5
24C3MX	38	1 1/2	1 1/2 - 11	59.2	67.1	48	2.3	2.0	1.3

JTX

Union Tee
37° Flare (all three ends)

SAE 070401
HPD Base # 033T

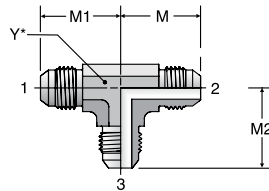

Y* – Across wrench flats

TUBE FITTING PART #	END SIZE			M (in.)	M1 (in.)	M2 (in.)	Y (in.)	Dynamic Pressure (x 1,000 PSI)		
	1	2	3					-S	-SS	-B
	(in.)	(in.)	(in.)							
2 JTX	1/8	1/8	1/8	0.77	0.77	0.77	5/16	7.5	7.7	3.3
3 JTX	3/16	3/16	3/16	0.83	0.83	0.83	7/16	7.5	7.7	3.3
4 JTX	1/4	1/4	1/4	0.89	0.89	0.89	7/16	7.5	7.7	3.3
4-4-3 JTX	1/4	1/4	3/16	0.89	0.89	0.81	7/16	7.5	7.7	3.3
5 JTX	5/16	5/16	5/16	0.95	0.95	0.95	9/16	6.0	6.0	3.3
6 JTX	3/8	3/8	3/8	1.06	1.06	1.06	9/16	6.0	6.0	3.3
8 JTX	1/2	1/2	1/2	1.25	1.25	1.25	3/4	6.0	6.0	3.3
10 JTX	5/8	5/8	5/8	1.45	1.45	1.45	7/8	5.0	5.0	3.3
12 JTX	3/4	3/4	3/4	1.66	1.66	1.66	1 1/16	5.0	5.0	2.9
12-12-8 JTX	3/4	3/4	1/2	1.66	1.66	1.42	1 1/16	5.0	5.0	2.9
12-16-12 JTX	3/4	1	3/4	1.77	1.81	1.77	1 5/16	4.0	3.5	2.3
14 JTX	7/8	7/8	7/8	1.80	1.80	1.80	1 5/16	5.0	5.0	2.9
16 JTX	1	1	1	1.81	1.81	1.81	1 5/16	4.0	3.5	2.3
20 JTX	1 1/4	1 1/4	1 1/4	2.06	2.06	2.06	1 5/8	4.0	3.0	2.0
24 JTX	1 1/2	1 1/2	1 1/2	2.33	2.33	2.33	1 7/8	3.0	2.0	1.5
24-16-16 JTX	1 1/2	1	1	2.33	2.16	2.16	1 7/8	3.0	2.0	1.5
32 JTX	2	2	2	3.06	3.06	3.06	2 1/2	2.0	1.5	1.0

Dimensions and pressures for reference only, subject to change.



WJTX

Bulkhead Branch Tee
37° Flare (all three ends)

SAE 070959
HPD Base # 543T
WJTX-WLN – Body with locknut
(See page B10 for WLN)

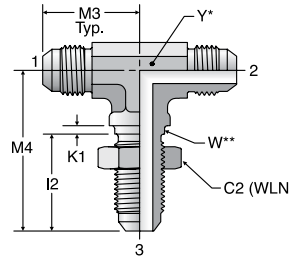

Y* – Across wrench flats.
W** – Bulkhead pilot dia.
recommended clearance hole
+.015 over W dia.

TUBE FITTING PART #	END SIZE (in.)	C2 HEX (in.)	I2 (in.)	K1 (in.)	M3 (in.)	M4 (in.)	W DIA (in.)	MAX BULKHEAD WALL THICKNESS (in.)	Y (in.)	Dynamic Pressure (x 1,000 PSI)		
										-S	-SS	-B
4 WJTX	1/4	11/16	1.02	0.09	0.97	1.59	0.44	0.25	7/16	7.5	7.7	3.3
6 WJTX	3/8	13/16	1.09	0.09	1.09	1.81	0.56	0.35	9/16	6.0	6.0	3.3
8 WJTX	1/2	1	1.25	0.13	1.36	2.11	0.75	0.35	3/4	6.0	6.0	3.3
10 WJTX	5/8	1 1/8	1.39	0.13	1.56	2.39	0.88	0.35	1 1/16	5.0	5.0	3.3
12 WJTX	3/4	1 3/8	1.56	0.13	1.78	2.67	1.06	0.35	1 1/16	5.0	5.0	2.9
16 WJTX	1	1 5/8	1.56	0.13	1.94	2.80	1.31	0.35	1 5/16	4.0	3.5	2.3
20 WJTX***	1 1/4	1 7/8	1.61	0.13	2.17	3.12	1.63	0.35	1 5/8	4.0	3.0	2.0

***Machined from one-piece milled bar stock.

WJJTX

Bulkhead Run Tee
37° Flare (all three ends)

SAE 070958
HPD Base # 533T
WJJTX-WLN – Body with locknut
(See page B10 for WLN)

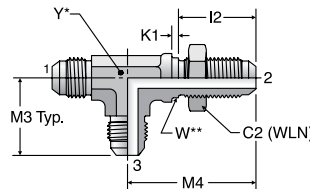

Y* – Across wrench flats.
W** – Bulkhead pilot dia.
recommended clearance hole
+.015 over W dia.

TUBE FITTING PART #	END SIZE (in.)	C2 HEX (in.)	I2 (in.)	K1 (in.)	M3 (in.)	M4 (in.)	W DIA (in.)	MAX BULKHEAD WALL THICKNESS (in.)	Y (in.)	Dynamic Pressure (x 1,000 PSI)		
										-S	-SS	-B
4 WJJTX	1/4	11/16	1.02	0.09	0.97	1.59	0.44	0.25	7/16	7.5	7.7	3.3
6 WJJTX	3/8	13/16	1.09	0.09	1.09	1.81	0.56	0.35	9/16	6.0	6.0	3.3
8 WJJTX	1/2	1	1.25	0.13	1.36	2.11	0.75	0.35	3/4	6.0	6.0	3.3
10 WJJTX	5/8	1 1/8	1.39	0.13	1.56	2.39	0.88	0.35	7/8	5.0	5.0	3.3
12 WJJTX	3/4	1 3/8	1.56	0.13	1.78	2.67	1.06	0.35	1 1/16	5.0	5.0	2.9
16 WJJTX***	1	1 5/8	1.56	0.13	1.94	2.80	1.31	0.35	1 7/16	4.0	3.5	2.3
20 WJJTX***	1 1/4	1 7/8	1.61	0.13	2.17	3.12	1.63	0.35	1 5/8	4.0	3.0	2.0

***Machined from one-piece milled bar stock.

Dimensions and pressures for reference only, subject to change.

JX6

Swivel Nut Union Tee
37° Swivel (all three ends)

HPD Base # 069T

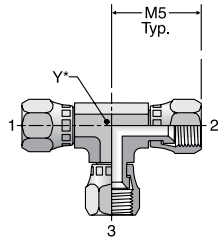

Y* – Across wrench flats

TUBE FITTING PART #	END SIZE			Dynamic Pressure (x 1,000 PSI)		
	1-3 (in.)	M5 (in.)	Y (in.)	-S	-SS	-B
				7.5	7.7	3.3
4 JX6	1/4	1.00	7/16	7.5	7.7	3.3
6 JX6	3/8	1.25	9/16	6.0	6.0	3.3
8 JX6	1/2	1.38	3/4	6.0	6.0	3.3
10 JX6	5/8	1.62	3/4	5.0	5.0	3.3
12 JX6	3/4	1.75	1 1/16	5.0	5.0	3.3
16 JX6	1	2.00	1 3/16	4.0	3.0	2.6

S6X

Swivel Nut Branch Tee
37° Flare / 37° Flare / 37° Swivel

SAE 070433

HPD Base # 393T

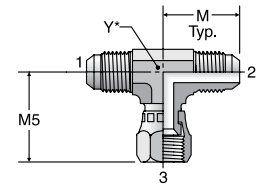

Y* – Across wrench flats

TUBE FITTING PART #	END SIZE				Dynamic Pressure (x 1,000 PSI)		
	1-3 (in.)	M (in.)	M5 (in.)	Y (in.)	-S	-SS	-B
					7.5	7.7	3.3
4 S6X	1/4	0.89	1.00	7/16	7.5	7.7	3.3
5 S6X	5/16	0.95	1.06	9/16	6.0	6.0	3.3
6 S6X	3/8	1.06	1.25	9/16	6.0	6.0	3.3
8 S6X	1/2	1.25	1.38	3/4	6.0	6.0	3.3
10 S6X	5/8	1.45	1.62	7/8	5.0	5.0	3.3
12 S6X	3/4	1.66	1.75	1 1/16	5.0	5.0	3.3
14 S6X	7/8	1.80	1.78	1 5/16	5.0	5.0	3.3
16 S6X	1	1.81	2.00	1 5/16	4.0	3.0	2.6
20 S6X	1 1/4	2.06	2.31	1 5/8	4.0	3.0	2.6
24 S6X	1 1/2	2.33	2.59	1 7/8	3.0	2.5	2.0

R6X

Swivel Nut Run Tee
37° Flare / 37° Swivel / 37° Flare

SAE 070432

HPD Base # 063T

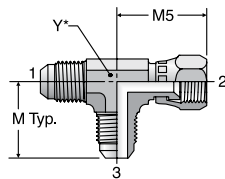

Y* – Across wrench flats

TUBE FITTING PART #	END SIZE				Dynamic Pressure (x 1,000 PSI)		
	1-3 (in.)	M (in.)	M5 (in.)	Y (in.)	-S	-SS	-B
					7.5	7.7	3.3
4 R6X	1/4	0.89	1.00	7/16	7.5	7.7	3.3
5 R6X	5/16	0.95	1.06	9/16	6.0	6.0	3.3
6 R6X	3/8	1.06	1.25	9/16	6.0	6.0	3.3
8 R6X	1/2	1.25	1.38	3/4	6.0	6.0	3.3
10 R6X	5/8	1.45	1.62	7/8	5.0	5.0	3.3
12 R6X	3/4	1.66	1.75	1 1/16	5.0	5.0	3.3
14 R6X	7/8	1.80	1.78	1 5/16	5.0	5.0	3.3
16 R6X	1	1.81	2.00	1 5/16	4.0	3.0	2.6
20 R6X	1 1/4	2.06	2.31	1 5/8	4.0	3.0	2.6
24 R6X	1 1/2	2.33	2.59	1 7/8	3.0	2.5	2.0

Dimensions and pressures for reference only, subject to change.

S50X

Straight Thread Branch Tee
37° Flare / 37° Flare /
SAE-ORB

SAE 070429
HPD Base # 253T

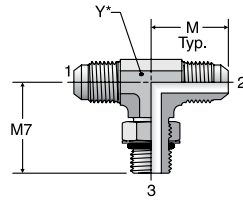

Y* – Across wrench flats

TUBE FITTING PART #	END SIZE			M (in.)	M7 (in.)	Y (in.)	Dynamic Pressure (x 1,000 PSI)			
	1 (in.)	2 (in.)	3 UN/UNF-2A (in.)				-S	-SS	-B	-D
4 S50X	1/4	1/4	7/16 - 20	0.89	1.03	7/16	6.0	6.0	3.3	3.0
4-4-6 S50X	1/4	1/4	9/16 - 18	1.05	1.25	9/16	6.0	5.4	3.3	3.0
5 S50X	5/16	5/16	1/2 - 20	0.97	1.13	9/16	6.0	5.4	3.3	3.0
6 S50X	3/8	3/8	9/16 - 18	1.06	1.25	9/16	6.0	5.4	3.3	3.0
6-6-8 S50X	3/8	3/8	3/4 - 16	1.14	1.45	3/4	6.0	5.4	3.3	3.0
8 S50X	1/2	1/2	3/4 - 16	1.25	1.45	3/4	6.0	5.4	3.3	3.0
8-8-10 S50X	1/2	1/2	7/8 - 14	1.33	1.70	7/8	5.0	5.4	3.3	2.5
10 S50X	5/8	5/8	7/8 - 14	1.45	1.70	7/8	5.0	5.4	3.3	2.5
10-10-12 S50X	5/8	5/8	1 1/16 - 12	1.53	1.94	1 1/16	5.0	5.4	3.3	2.5
12 S50X	3/4	3/4	1 1/16 - 12	1.66	1.94	1 1/16	5.0	5.4	3.3	2.5
12-12-16 S50X	3/4	3/4	1 5/16 - 12	1.76	2.05	1 5/16	4.0	3.0	2.6	2.0
16 S50X	1	1	1 5/16 - 12	1.81	2.05	1 5/16	4.0	3.0	2.6	2.0
20 S50X	1 1/4	1 1/4	1 5/8 - 12	2.06	2.25	1 5/8	4.0	2.5	2.0	•
24 S50X	1 1/2	1 1/2	1 7/8 - 12	2.33	2.39	1 7/8	3.0	2.0	1.5	•
32 S50X	2	2	2 1/2 - 12	3.06	2.89	2 1/2	2.0	1.5	1.3	•

R50X

Straight Thread Run Tee
37° Flare / SAE-ORB /
37° Flare

SAE 070428
HPD Base # 053T

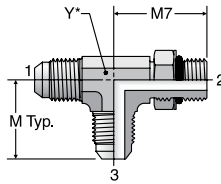

Y* – Across wrench flats

TUBE FITTING PART #	END SIZE			M (in.)	M7 (in.)	Y (in.)	Dynamic Pressure (x 1,000 PSI)			
	1 (in.)	2 UN/UNF-2A (in.)	3 (in.)				-S	-SS	-B	-D
4 R50X	1/4	7/16 - 20	1/4	0.89	1.03	7/16	6.0	6.0	3.3	3.0
4-6-4 R50X	1/4	9/16 - 18	1/4	1.05	1.25	9/16	6.0	5.4	3.3	3.0
5 R50X	5/16	1/2 - 20	5/16	0.97	1.13	9/16	6.0	5.4	3.3	3.0
6 R50X	3/8	9/16 - 18	3/8	1.06	1.25	9/16	6.0	5.4	3.3	3.0
6-8-6 R50X	3/8	3/4 - 16	3/8	1.14	1.45	3/4	6.0	5.4	3.3	3.0
8 R50X	1/2	3/4 - 16	1/2	1.25	1.45	3/4	6.0	5.4	3.3	3.0
8-6-8 R50X	1/2	9/16 - 18	1/2	1.25	1.33	3/4	6.0	5.4	3.3	3.0
8-10-8 R50X	1/2	7/8 - 14	1/2	1.33	1.70	7/8	5.0	5.4	3.3	2.5
8-12-8 R50X	1/2	1 1/16 - 12	1/2	1.42	1.94	1 1/16	5.0	5.4	3.3	2.5
10 R50X	5/8	7/8 - 14	5/8	1.45	1.70	7/8	5.0	5.4	3.3	2.5
10-12-10 R50X	5/8	1 1/16 - 12	5/8	1.53	1.94	1 1/16	5.0	5.4	3.3	2.5
12 R50X	3/4	1 1/16 - 12	3/4	1.66	1.94	1 1/16	5.0	5.4	3.3	2.5
12-16-12 R50X	3/4	1 5/16 - 12	3/4	1.76	2.05	1 5/16	4.0	3.0	2.6	2.0
16 R50X	1	1 5/16 - 12	1	1.81	2.05	1 5/16	4.0	3.0	2.6	2.0
20 R50X	1 1/4	1 5/8 - 12	1 1/4	2.06	2.25	1 5/8	4.0	2.5	2.0	•
24 R50X	1 1/2	1 7/8 - 12	1 1/2	2.33	2.39	1 7/8	3.0	2.0	1.5	•
32 R50X	2	2 1/2 - 12	2	3.06	2.89	2 1/2	2.0	1.5	1.3	•

Dimensions and pressures for reference only, subject to change.

STX

Male Branch Tee
37° Flare / 37° Flare / NPTF

SAE 070425
HPD Base # 213T

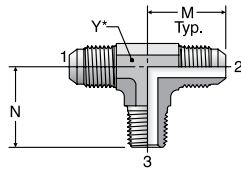

Y* – Across wrench flats

TUBE FITTING PART #	END SIZE		M (in.)	N (in.)	Y (in.)	Dynamic Pressure (x 1,000 PSI)		
	1 & 2 (in.)	3 NPTF				-S	-SS	-B
	3 STX	3/16						
4 STX	1/4	1/8 - 27	0.89	0.78	7/16	6.0	6.0	3.3
4-4-4 STX	1/4	1/4 - 18	1.05	1.09	9/16	6.0	6.0	3.3
4-4-6 STX	1/4	3/8 - 18	1.12	1.22	3/4	6.0	6.0	3.3
5 STX	5/16	1/8 - 27	0.95	0.78	9/16	6.0	6.0	3.3
5-5-4 STX	5/16	1/4 - 18	1.05	1.09	9/16	6.0	6.0	3.3
6 STX	3/8	1/4 - 18	1.06	1.09	9/16	6.0	6.0	3.3
6-6-6 STX	3/8	3/8 - 18	1.14	1.22	3/4	6.0	6.0	3.3
8 STX	1/2	3/8 - 18	1.25	1.22	3/4	6.0	6.0	3.3
8-8-8 STX	1/2	1/2 - 14	1.33	1.47	7/8	6.0	6.0	3.3
10 STX	5/8	1/2 - 14	1.45	1.47	7/8	5.0	5.0	3.3
12 STX	3/4	3/4 - 14	1.66	1.59	1 1/16	4.0	4.0	2.6
14 STX	7/8	3/4 - 14	1.80	1.69	1 5/16	4.0	4.0	2.3
16 STX	1	1 - 11 1/2	1.81	1.97	1 5/16	3.0	3.0	2.0
20 STX	1 1/4	1 1/4 - 11 1/2	2.06	2.38	1 5/8	2.5	2.5	1.6
24 STX	1 1/2	1 1/2 - 11 1/2	2.33	2.64	1 7/8	2.5	2.5	1.6

RTX

Male Run Tee
37° Flare / NPTF / 37° Flare

SAE 070424
HPD Base # 013T

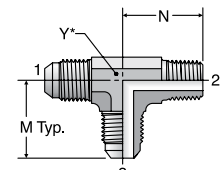

Y* – Across wrench flats

TUBE FITTING PART #	END SIZE		M (in.)	N (in.)	Y (in.)	Dynamic Pressure (x 1,000 PSI)		
	1 & 2 (in.)	3 NPTF				-S	-SS	-B
	3 RTX	3/16						
4 RTX	1/4	1/8 - 27	0.89	0.78	7/16	6.0	6.0	3.3
4-4-4 RTX	1/4	1/4 - 18	1.05	1.09	9/16	6.0	6.0	3.3
5 RTX	5/16	1/8 - 27	0.95	0.78	9/16	6.0	6.0	3.3
5-4-5 RTX	5/16	1/4 - 18	1.05	1.09	9/16	6.0	6.0	3.3
6 RTX	3/8	1/4 - 18	1.06	1.09	9/16	6.0	6.0	3.3
6-6-6 RTX	3/8	3/8 - 18	1.14	1.22	3/4	6.0	6.0	3.3
8 RTX	1/2	3/8 - 18	1.25	1.22	3/4	6.0	6.0	3.3
8-8-8 RTX	1/2	1/2 - 14	1.33	1.47	7/8	6.0	6.0	3.3
10 RTX	5/8	1/2 - 14	1.45	1.47	7/8	5.0	5.0	3.3
12 RTX	3/4	3/4 - 14	1.66	1.59	1 1/16	4.0	4.0	2.6
12-8-12 RTX	3/4	1/2 - 14	1.66	1.59	1 1/16	5.0	5.0	2.9
14 RTX	7/8	3/4 - 14	1.80	1.69	1 5/16	4.0	4.0	2.3
16 RTX	1	1 - 11 1/2	1.81	1.97	1 5/16	3.0	3.0	2.0
20 RTX	1 1/4	1 1/4 - 11 1/2	2.06	2.38	1 5/8	2.5	2.5	1.6
24 RTX	1 1/2	1 1/2 - 11 1/2	2.33	2.64	1 7/8	2.5	2.5	1.6

OTX

Female Branch Tee
37° Flare / 37° Flare / NPTF

SAE 070427
HPD Base # 223T

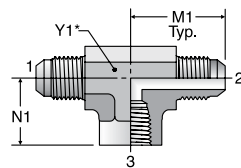

Y* – Across wrench flats

TUBE FITTING PART #	END SIZE		M1 (in.)	N1 (in.)	Y1 (in.)	Dynamic Pressure (x 1,000 PSI)		
	1 & 2 (in.)	3 NPTF				-S	-SS	-B
	4 OTX	1/4						
4-4-4 OTX	1/4	1/4 - 18	1.13	0.88	3/4	5.0	5.0	3.3
5 OTX	5/16	1/8 - 27	1.08	0.66	9/16	5.0	5.0	3.3
6 OTX	3/8	1/4 - 18	1.23	0.88	3/4	5.0	5.0	3.3
6-6-6 OTX	3/8	3/8 - 18	1.23	1.02	7/8	4.5	4.5	2.9
8 OTX	1/2	3/8 - 18	1.42	1.02	7/8	4.5	4.5	2.9
8-8-8 OTX	1/2	1/2 - 14	1.42	1.23	1 1/16	3.0	3.0	2.0
10 OTX	5/8	1/2 - 14	1.64	1.23	1 1/16	3.0	3.0	2.0
12 OTX	3/4	3/4 - 14	1.89	1.36	1 5/16	3.0	3.0	2.0
14 OTX	7/8	3/4 - 14	1.86	1.42	1 5/16	3.0	3.0	2.0
16 OTX	1	1 - 11 1/2	2.17	1.62	1 5/8	1.8	1.8	1.2
20 OTX	1 1/4	1 1/4 - 11 1/2	2.33	1.70	1 7/8	1.5	1.5	1.0
24 OTX	1 1/2	1 1/2 - 11 1/2	2.89	2.08	2 1/2	1.5	1.5	1.0

MTX

Female Run Tee
37° Flare / NPTF / 37° Flare

SAE 070426
HPD Base # 023T

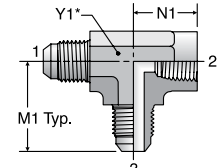

Y* – Across wrench flats

TUBE FITTING PART #	END SIZE		M1 (in.)	N1 (in.)	Y1 (in.)	Dynamic Pressure (x 1,000 PSI)		
	1 & 3 (in.)	2 NPTF				-S	-SS	-B
	4 MTX	1/4						
4-4-4 MTX	1/4	1/4 - 18	1.13	0.88	3/4	5.0	5.0	3.3
6 MTX	3/8	1/4 - 18	1.23	0.88	3/4	5.0	5.0	3.3
8 MTX	1/2	3/8 - 18	1.42	1.02	7/8	4.5	4.5	2.9
8-8-8 MTX	1/2	1/2 - 14	1.42	1.23	1 1/16	3.0	3.0	2.0
10 MTX	5/8	1/2 - 14	1.64	1.23	1 1/16	3.0	3.0	2.0
12 MTX	3/4	3/4 - 14	1.89	1.36	1 5/16	3.0	3.0	2.0
14 MTX	7/8	3/4 - 14	1.86	1.42	1 5/16	3.0	3.0	2.0
16 MTX	1	1 - 11 1/2	2.17	1.62	1 5/8	1.8	1.8	1.2
20 MTX	1 1/4	1 1/4 - 11 1/2	2.33	1.70	1 7/8	1.5	1.5	1.0
24 MTX	1 1/2	1 1/2 - 11 1/2	2.89	2.08	2 1/2	1.5	1.5	1.0

Dimensions and pressures for reference only, subject to change.



S870MX

ISO 6149 Branch Tee
37° Flare / 37° Flare / ISO 6149

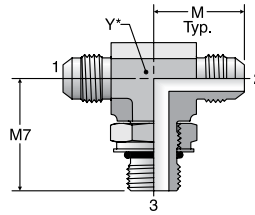

Y* – Across wrench flats

TUBE FITTING PART #	END SIZE		Male Metric Parallel Thread	M (mm)	M7 (mm)	Y (mm)	Dynamic Pressure (x 1,000 PSI)			
	1 & 2						3	-S	-SS	-B
	(mm)	(in.)								
6M14S870MX	10	3/8	M14 x 1.5	26.9	33.5	14	6.0	6.0	3.3	
8M16S870MX	12	1/2	M16 x 1.5	31.8	38.0	19	5.0	5.0	3.3	
10M22S870MX	14,15,16	5/8	M22 x 1.5	36.8	42.5	22	5.0	5.0	3.3	
12M27S870MX	18,20	3/4	M27 x 2	42.2	51.0	27	5.0	5.0	3.3	

R870MX

ISO 6149 Run Tee
37° Flare / ISO 6149 / 37° Flare

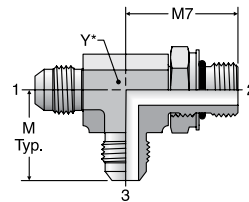

Y* – Across wrench flats

TUBE FITTING PART #	END SIZE		Male Metric Parallel Thread	M (mm)	M7 (mm)	Y (mm)	Dynamic Pressure (x 1,000 PSI)			
	1 & 3						2	-S	-SS	-B
	(mm)	(in.)								
6M14R870MX	10	3/8	M14 x 1.5	26.9	33.5	14	6.0	6.0	3.3	
8M16R870MX	12	1/2	M16 x 1.5	31.8	38.0	19	5.0	5.0	3.3	
10M22R870MX	14,15,16	5/8	M22 x 1.5	36.8	42.5	22	5.0	5.0	3.3	
12M27R870MX	18, 20	3/4	M27 x 1.5	42.2	51.0	27	5.0	5.0	3.3	

S40MX

Male Branch Tee – BSPP
37° Flare / 37° Flare /
BSPP-ORR

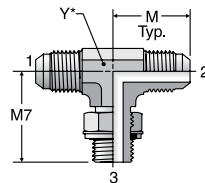

Y* – Across wrench flats

R40MX

Male Run Tee – BSPP
37° Flare / BSPP-ORR /
37° Flare

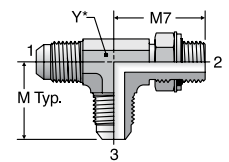

Y* – Across wrench flats

TUBE FITTING PART #	END SIZE			M (mm)	M7 (mm)	Y (mm)	Dynamic Pressure (x 1,000 PSI)		
	1 & 2		3				-S	-SS	-B
	(mm)	(in.)							
4S40MX	6	1/4	1/8 - 28	22.6	26.5	11	3.6	3.6	2.3
6S40MX	10	3/8	1/4 - 19	26.9	32.0	14	3.6	2.9	1.9
8S40MX	12	1/2	3/8 - 19	31.8	37.0	19	3.6	2.9	1.9
10S40MX	14,15,16	5/8	1/2 - 14	36.8	43.0	22	3.6	2.9	1.9
12S40MX	18,20	3/4	3/4 - 14	42.2	49.5	27	3.6	2.9	1.9
16S40MX	25	1	1 - 11	46.0	52.0	33	3.6	2.9	1.9

TUBE FITTING PART #	END SIZE			M (mm)	M7 (mm)	Y (mm)	Dynamic Pressure (x 1,000 PSI)		
	1 & 3		2				-S	-SS	-B
	(mm)	(in.)							
4R40MX	6	1/4	1/8 - 28	22.6	26.5	11	3.6	3.6	2.3
6R40MX	10	3/8	1/4 - 19	26.6	32.0	14	3.6	2.9	1.9
8R40MX	12	1/2	3/8 - 19	31.8	36.8	19	3.6	2.9	1.9
10R40MX	14,15,16	5/8	1/2 - 14	36.8	43.0	22	3.6	2.9	1.9
12R40MX	18,20	3/4	3/4 - 14	42.2	49.5	27	3.6	2.9	1.9
16R40MX	25	1	1 - 11	46.0	52.0	33	3.6	2.9	1.9
20R40MX	28, 30, 32	1 1/4	1 1/4 - 11	52.3	57.0	41	3.0	2.3	1.5

Dimensions and pressures for reference only, subject to change.



KTX

Union Cross
37° Flare (all four ends)

SAE 070501
HPD Base # 033X

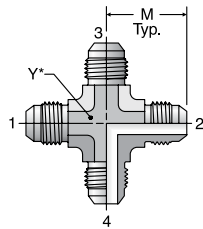

Y* – Across wrench flats

TUBE FITTING PART #	END SIZE	M (in.)	Y (in.)	Dynamic Pressure (x 1,000 PSI)		
				-S	-SS	-B
	4 KTX	1/4	0.89	7/16	7.5	7.7
5 KTX	5/16	0.95	9/16	6.0	6.0	3.3
6 KTX	3/8	1.06	9/16	6.0	6.0	3.3
8 KTX	1/2	1.25	3/4	6.0	6.0	3.3
10 KTX	5/8	1.45	7/8	5.0	5.0	3.3
12 KTX	3/4	1.66	1 1/16	5.0	5.0	2.9
16 KTX	1	1.81	1 5/16	4.0	3.5	2.3

PNTX

Plug
37° Flare

SAE 070109
HPD Base # 03CP

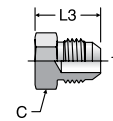

TUBE FITTING PART #	END SIZE	C HEX (in.)	L3 (in.)	Dynamic Pressure (x 1,000 PSI)		
				-S	-SS	-B
	2 PNTX	1/8	7/16	0.70	7.5	9
3 PNTX	3/16	7/16	0.73	7.5	9	3.3
4 PNTX	1/4	1/2	0.80	7.5	9	3.3
5 PNTX	5/16	9/16	0.80	6.0	7.2	3.3
6 PNTX	3/8	5/8	0.84	6.0	7.2	3.3
8 PNTX	1/2	13/16	0.94	6.0	7.2	3.3
10 PNTX	5/8	15/16	1.10	5.0	6.0	3.3
12 PNTX	3/4	1 1/8	1.28	5.0	6.0	3.3
14 PNTX	7/8	1 1/4	1.31	5.0	5.0	3.3
16 PNTX	1	1 3/8	1.33	4.5	5.4	2.9
20 PNTX	1 1/4	1 11/16	1.45	4.0	4.8	2.6
24 PNTX	1 1/2	2	1.65	4.0	4.8	2.6
32 PNTX	2	2 5/8	2.05	2.0	2.4	1.3

FNTX

Cap
37° Flare

SAE 070112A
HPD Base # 06CP

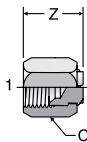

TUBE FITTING PART #	END SIZE	C HEX (in.)	Z (in.)	Dynamic Pressure (x 1,000 PSI)		
				-S	-SS	-B
	2 FNTX	1/8	3/8	0.60	7.5	9.0
3 FNTX	3/16	7/16	0.66	7.5	9.0	3.3
4 FNTX	1/4	9/16	0.67	7.5	9.0	3.3
5 FNTX	5/16	5/8	0.77	6.0	7.2	3.3
6 FNTX	3/8	11/16	0.81	6.0	7.2	3.3
8 FNTX	1/2	7/8	0.94	6.0	7.2	3.3
10 FNTX	5/8	1	1.07	5.0	6.0	3.3
12 FNTX	3/4	1 1/4	1.24	5.0	6.0	3.3
14 FNTX	7/8	1 3/8	1.26	5.0	6.0	3.3
16 FNTX	1	1 1/2	1.29	4.5	5.4	2.9
20 FNTX	1 1/4	2	1.39	4.0	4.8	2.6
24 FNTX	1 1/2	2 1/4	1.70	3.0	3.6	2.0
32 FNTX	2	2 7/8	2.01	2.0	2.4	1.3

T22X

Mountie Cap

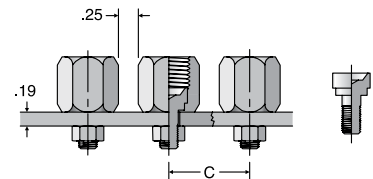

TUBE FITTING PART #	END SIZE		C (in.)	L (in.)	Dynamic Pressure (x 1,000 PSI)		
	1 (in.)	2 UNC/UNF-2A			-S	-SS	-B
	4 T22X	1/4	1/4 - 20	0.91	0.72	7.5	9.0
6 T22X	3/8	1/4 - 20	1.08	0.81	6.0	7.2	3.3
8 T22X	1/2	5/16 - 18	1.25	0.97	6.0	7.2	3.3

Dimensions and pressures for reference only, subject to change.

HTXO

Union
37° Flare

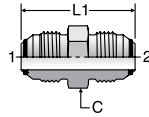

TUBE FITTING PART #	END SIZE		C HEX (in.)	L1 (in.)	Dynamic Pressure (x 1,000 PSI) -SS
	1 & 2 (in.)				
4 HTXO	1/4		1/2	1.39	9.0
6 HTXO	3/8		5/8	1.42	7.7
8 HTXO	1/2		13/16	1.66	7.7
10 HTXO	5/8		15/16	1.98	6.0
12 HTXO	3/4		1 1/8	2.24	6.0
16 HTXO	1		1 3/8	2.41	5.4
20 HTXO	1 1/4		1 11/16	2.58	5.0
24 HTXO	1 1/2		2	2.90	5.0

F5OXO

Straight Thread Connector
37° Flare / SAE-ORB

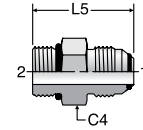

TUBE FITTING PART #	END SIZE		C4 HEX (in.)	L5 (in.)	Dynamic Pressure (x 1,000 PSI) -SS
	1 (in.)	2			
	(in.)	UN/UNF-2A			
4 F5OXO	1/4	7/16 - 20	9/16	1.23	9.0
4-6 F5OXO	1/4	9/16 - 18	11/16	1.28	7.7
6 F5OXO	3/8	9/16 - 18	11/16	1.30	7.7
6-4 F5OXO	3/8	7/16 - 20	5/8	1.27	7.7
6-8 F5OXO	3/8	3/4 - 16	7/8	1.38	7.7
8 F5OXO	1/2	3/4 - 16	7/8	1.48	7.7
8-6 F5OXO	1/2	9/16 - 18	13/16	1.44	7.7
10 F5OXO	5/8	7/8 - 14	1	1.75	6.0
12 F5OXO	3/4	1 1/16 - 12	1 1/4	1.97	6.0
16 F5OXO	1	1 5/16 - 12	1 1/2	2.05	5.4
20 F5OXO	1 1/4	1 5/8 - 12	1 7/8	2.17	5.0
24 F5OXO	1 1/2	1 7/8 - 12	2 1/8	2.37	4.0
32 F5OXO	2	2 1/2 - 12	2 3/4	2.78	2.4

FTXO

Male Connector
37° Flare / NPTF

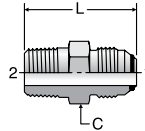

TUBE FITTING PART #	END SIZE		C HEX (in.)	L (in.)	Dynamic Pressure (x 1,000 PSI) -SS
	1 (in.)	2 NPTF			
4 FTXO	1/4	1/8 - 27	1/2	1.23	6.0
4-4 FTXO	1/4	1/4 - 18	9/16	1.43	6.0
6 FTXO	3/8	1/4 - 18	5/8	1.45	6.0
6-6 FTXO	3/8	3/8 - 18	3/4	1.46	6.0
8 FTXO	1/2	3/8 - 18	13/16	1.53	6.0
8-8 FTXO	1/2	1/2 - 14	7/8	1.78	6.0
10 FTXO	5/8	1/2 - 14	15/16	1.94	5.0
12 FTXO	3/4	3/4 - 14	1 1/8	2.10	5.0
16 FTXO	1	1 - 11 1/2	1 3/8	2.38	4.5
20 FTXO	1 1/4	1 1/4 - 11 1/2	1 11/16	2.52	3.0
24 FTXO	1 1/2	1 1/2 - 11 1/2	2	2.76	3.0
32 FTXO	2	2 - 11 1/2	2 5/8	3.18	2.0

GTXO

Female Connector
37° Flare / NPTF

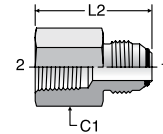

TUBE FITTING PART #	END SIZE		C1 HEX (in.)	L2 (in.)	Dynamic Pressure (x 1,000 PSI) -SS
	1 (in.)	2 NPTF			
4 GTXO	1/4	1/8 - 27	9/16	1.20	6.0
6 GTXO	3/8	1/4 - 18	3/4	1.41	6.0
8 GTXO	1/2	3/8 - 18	7/8	1.58	6.0
10 GTXO	5/8	1/2 - 14	1 1/8	1.94	5.0
12 GTXO	3/4	3/4 - 14	1 3/8	2.10	4.8
16 GTXO	1	1 - 11 1/2	1 5/8	2.43	3.6
20 GTXO	1 1/4	1 1/4 - 11 1/2	2	2.56	3.0
24 GTXO	1 1/2	1 1/2 - 11 1/2	2 3/8	2.70	2.4

Dimensions and pressures for reference only, subject to change.

ETXO

Union Elbow
37° Flare / 37° Flare

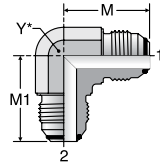

TUBE FITTING PART #	END SIZE		M (in.)	M1 (in.)	Y (in.)	Dynamic Pressure (x 1,000 PSI) -SS
	1 & 2 (in.)					
4 ETXO	1/4		0.90	0.90	7/16	7.7
6 ETXO	3/8		1.08	1.08	9/16	6.0
8 ETXO	1/2		1.25	1.25	3/4	6.0
10 ETXO	5/8		1.50	1.50	7/8	5.0
12 ETXO	3/4		1.70	1.70	1 1/16	5.0
16 ETXO	1		1.89	1.89	1 5/16	5.0
20 ETXO	1 1/4		2.13	2.13	1 5/8	5.0
24 ETXO	1 1/2		2.41	2.41	1 7/8	5.0

C6XO

Swivel Nut Elbow
37° Flare / 37° Swivel

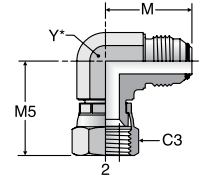

TUBE FITTING PART #	END SIZE		C3 (in.)	M (in.)	M5 (in.)	M10 (in.)	Y (in.)	Dynamic Pressure (x 1,000 PSI) -SS
	1 & 2 (in.)							
4 C6XO	1/4		9/16	0.90	1.00	0.66	7/16	7.7
6 C6XO	3/8		11/16	1.08	1.25	0.88	9/16	6.0
8 C6XO	1/2		7/8	1.25	1.38	0.95	3/4	6.0
10 C6XO	5/8		1	1.50	1.62	1.13	7/8	5.0
12 C6XO	3/4		1 1/4	1.70	1.75	1.19	1 1/16	5.0
16 C6XO	1		1 1/2	1.89	2.00	1.41	1 5/16	2.5
20 C6XO	1 1/4		2	2.13	2.31	1.69	1 5/8	2.5

CTXO

Male Elbow
37° Flare / NPTF

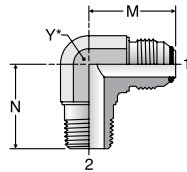

TUBE FITTING PART #	END SIZE		M (in.)	N (in.)	Y (in.)	Dynamic Pressure (x 1,000 PSI) -SS
	1 (in.)	2 NPTF				
4 CTXO	1/4	1/8 - 27	0.90	0.78	7/16	6.0
4-4 CTXO	1/4	1/4 - 18	1.06	1.09	9/16	6.0
6 CTXO	3/8	1/4 - 18	1.08	1.09	9/16	6.0
6-6 CTXO	3/8	3/8 - 18	1.16	1.22	3/4	6.0
8 CTXO	1/2	3/8 - 18	1.25	1.22	3/4	6.0
8-8 CTXO	1/2	1/2 - 14	1.33	1.47	7/8	6.0
10 CTXO	5/8	1/2 - 14	1.51	1.47	7/8	5.0
12 CTXO	3/4	3/4 - 14	1.70	1.59	1 1/16	4.0
16 CTXO	1	1 - 11 1/2	1.89	1.97	1 5/16	3.0
20 CTXO	1 1/4	1 1/4 - 11 1/2	2.13	2.38	1 5/8	2.5
24 CTXO	1 1/2	1 1/2 - 11 1/2	2.41	2.64	1 7/8	2.5
32 CTXO	2	2 - 11 1/2	3.13	3.00	2 1/2	2.0

C5OXO

Straight Thread Elbow
37° Flare / SAE-ORB

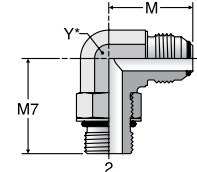

TUBE FITTING PART #	END SIZE		M (in.)	M7 (in.)	Y (in.)	Dynamic Pressure (x 1,000 PSI) -SS
	1 (in.)	2 UN/UNF-2A				
4 C5OXO	1/4	7/16 - 20	0.90	1.03	7/16	6.0
6 C5OXO	3/8	9/16 - 18	1.08	1.25	9/16	5.4
8 C5OXO	1/2	3/4 - 16	1.25	1.45	3/4	5.4
10 C5OXO	5/8	7/8 - 14	1.50	1.70	7/8	5.4
12 C5OXO	3/4	1 1/16 - 12	1.70	1.94	1 1/16	5.4
16 C5OXO	1	1 5/16 - 12	1.89	2.05	1 5/16	3.7
20 C5OXO	1 1/4	1 5/8 - 12	2.13	2.25	1 5/8	2.8
24 C5OXO	1 1/2	1 7/8 - 12	2.41	2.39	1 7/8	2.5
32 C5OXO	2	2 1/2 - 12	3.13	2.89	2 1/2	1.5

Dimensions and pressures for reference only, subject to change.

JTXO

Union Tee
37° Flare (all three ends)

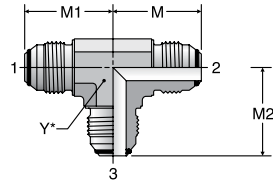

TUBE FITTING PART #	END SIZE					Dynamic Pressure (x 1,000 PSI) -SS
	1 - 3 (in.)	M (in.)	M1 (in.)	M2 (in.)	Y (in.)	
4 JTXO	1/4	0.90	0.90	0.90	7/16	7.7
6 JTXO	3/8	1.08	1.08	1.08	9/16	6.0
8 JTXO	1/2	1.25	1.25	1.25	3/4	6.0
10 JTXO	5/8	1.50	1.50	1.50	7/8	5.0
12 JTXO	3/4	1.70	1.70	1.70	1 1/16	5.0
16 JTXO	1	1.89	1.89	1.89	1 5/16	5.0
20 JTXO	1 1/4	2.13	2.13	2.13	1 5/8	5.0
24 JTXO	1 1/2	2.41	2.41	2.41	1 7/8	5.0

RTXO

Male Run Tee
37° Flare / NPTF / 37° Flare

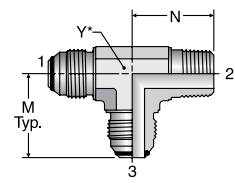

TUBE FITTING PART #	END SIZE		M (in.)	N (in.)	Y (in.)	Dynamic Pressure (x 1,000 PSI) -SS
	1 & 3 (in.)	2 NPTF				
4 RTXO	1/4	1/8 - 27	0.90	0.78	7/16	6.0
6 RTXO	3/8	1/4 - 18	1.08	1.09	9/16	6.0
8 RTXO	1/2	3/8 - 18	1.25	1.22	3/4	6.0
10 RTXO	5/8	1/2 - 14	1.51	1.47	7/8	5.0
12 RTXO	3/4	3/4 - 14	1.70	1.59	1 1/16	4.0
16 RTXO	1	1 - 11 1/2	1.89	1.97	1 5/16	3.0
20 RTXO	1 1/4	1 1/4 - 11 1/2	2.13	2.38	1 5/8	2.5
24 RTXO	1 1/2	1 1/2 - 11 1/2	2.41	2.64	1 7/8	2.5

R5OXO

Straight Thread Run Tee
37° Flare / SAE-ORB / 37° Flare

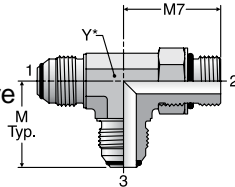

TUBE FITTING PART #	END SIZE		M (in.)	M7 (in.)	Y (in.)	Dynamic Pressure (x 1,000 PSI) -SS
	1 (in.)	2 UN/UNF-2A				
4 R5OXO	1/4	7/16 - 20	0.90	1.03	7/16	6.0
6 R5OXO	3/8	9/16 - 18	1.08	1.25	9/16	5.4
8 R5OXO	1/2	3/4 - 16	1.25	1.45	3/4	5.4
10 R5OXO	5/8	7/8 - 14	1.51	1.70	7/8	5.4
12 R5OXO	3/4	1 1/16 - 12	1.70	1.94	1 1/16	5.4
16 R5OXO	1	1 5/16 - 12	1.89	2.05	1 5/16	3.7
20 R5OXO	1 1/4	1 5/8 - 12	2.13	2.25	1 5/8	2.8

Dimensions and pressures for reference only, subject to change.

